

# 4HS

## 4" variable speed submersible pumps



## 4HS is a range of 4" electric submersible pumps for well applications, featuring:

- Three-phase, water-filled, permanent magnet synchronous motor with encapsulated resin stator, fully constructed of AISI 304 stainless steel.
- Built-in integrated inverter controlled by CM control module.
- Multistage pump made of AISI 304 stainless steel.

## An inverter allows 4HS to:

- Change pump speed to maintain set-pressure regardless of water demand. Consequently the pump is operated only when and as needed without wasting energy, thereby extending pump life.
- Starts and stops pump gently, thus reducing peak absorption, mechanical stress.
- Protects pump and drive from overload, undervoltage, surges, dry running and any abnormal conditions.

Integrated on-board inverter avoids the use of expensive filters and shielded cables reducing electromagnetic emissions to a minimum.

4HS product range meets the needs of commercial and residential markets for water supply, water pressurisation and irrigation.

Compared to conventional solutions, 4HS offers:

- Energy-saving operation.
- Quick and simplified application.
- System reliability.

Construction characteristics and use of specific materials allow 4HS to be suitable for drinking water applications.

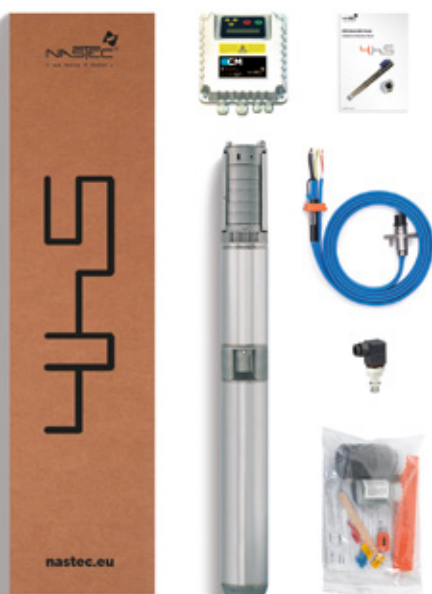

## A ready to use product

4HS range submersible pumps are designed to provide customers with a ready-to-use product, so they are packaged in a kit including:

- 4HS pump including 2.5 m / 8 ft flat cable lead (ACS-WRAS - KTM compliant)
- Surface control module (CM)
- Cable junction kit
- Pressure transducer 0-16 bar / 0-250 psi

Upon request, Nastec can provide communication and power cables of the desired length.

4HS pumps are made entirely of AISI 304 stainless steel to ensure the long life of their components

Pump, motor and hydraulic components are easily disassembled for simple maintenance and replacement operations.



## Centrifugal pump

- Impellers and diffusers in stainless steel.
- Built-in no-return valve.



## Motor

- Permanent magnet motor.
- Resined and encapsulated stator made of AISI 304 stainless steel.
- Water-cooled rotor.
- Kingsbury thrust bearing.



## Built-in inverter module (MINT)

- Completely resin-filled.
- Removable power cable.



# CM: Control Module

CM control module, mounted above-ground, manages the pump operation by changing pump speed to maintain the desired pressure in the system regardless of water demand.

Simply connect the pressure transducer, supplied as standard, and perform a quick set-up of the sensor to configure the pressure range for the system.

During operation, the CM control unit continuously monitors the electrical, hydraulic and

thermal parameters providing complete protection against surges, undervoltage, overload and dry running.



# Cable junction kit

The waterproof junction between the pump lead and drop cables is made using a kit consisting of:

- Polymer sheath containing the cable junctions
- Polyurethane resin
- Hardener
- Stick for mixing resin hardener

- Insulated cable connectors
- Instruction manual



To set up the system in a constant pressure application simply install the 4HS pump, connect the CM control module and wire the pressure sensor

A small pressure tank is normally used to compensate for water loss while the pump is not running.

The control module receives the pressure signal from the pressure transducers and varies pump speed to maintain a constant set pressure regardless of water demand.

In addition to the constant pressure control, CM can also manage the following control modes:

- fixed frequency
- constant flow
- constant temperature

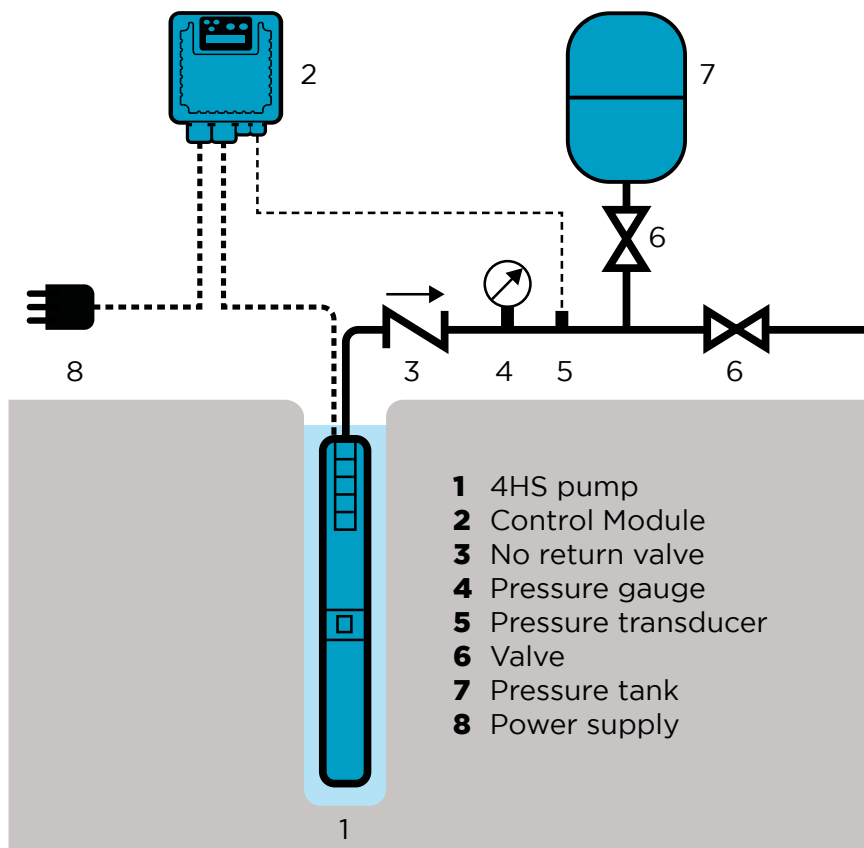

# Pump selection

Variable speed allows 4HS to cover a wide range of water flow and heads with just a few models; selecting the proper pump model for an application will help maximise performance and overall efficiency. Use the diagram below to select the most suitable 4HS pump model for your application.

# Energy saving

If the water demand decreases, 4HS will reduce the speed (proportional to the frequency) to maintain constant pressure. As you can see from the chart, a speed reduction corresponds a significant decrease of the power consumption. For example, maintaining constant the 6 bar (197 psi), if speed drops from 4800 rpm to 4200 rpm, input power decreases from 1600W to 700W.

# Thousand pumps

4HS can be used at a fixed speed by setting the operational frequency. To each frequency curve corresponds a different hydraulic performance and power consumption. This means that each 4HS model covers the performance offered by several standard pumps at fixed speed.

# Performance adapting

Among the parameters to be set in the CM control module, particularly useful is the possibility of limiting the maximum current absorbed by the pump. If this threshold is exceeded, for example in the even of a drop in input voltage, the control will reduce the 4HS pump speed to always ensure its operation.

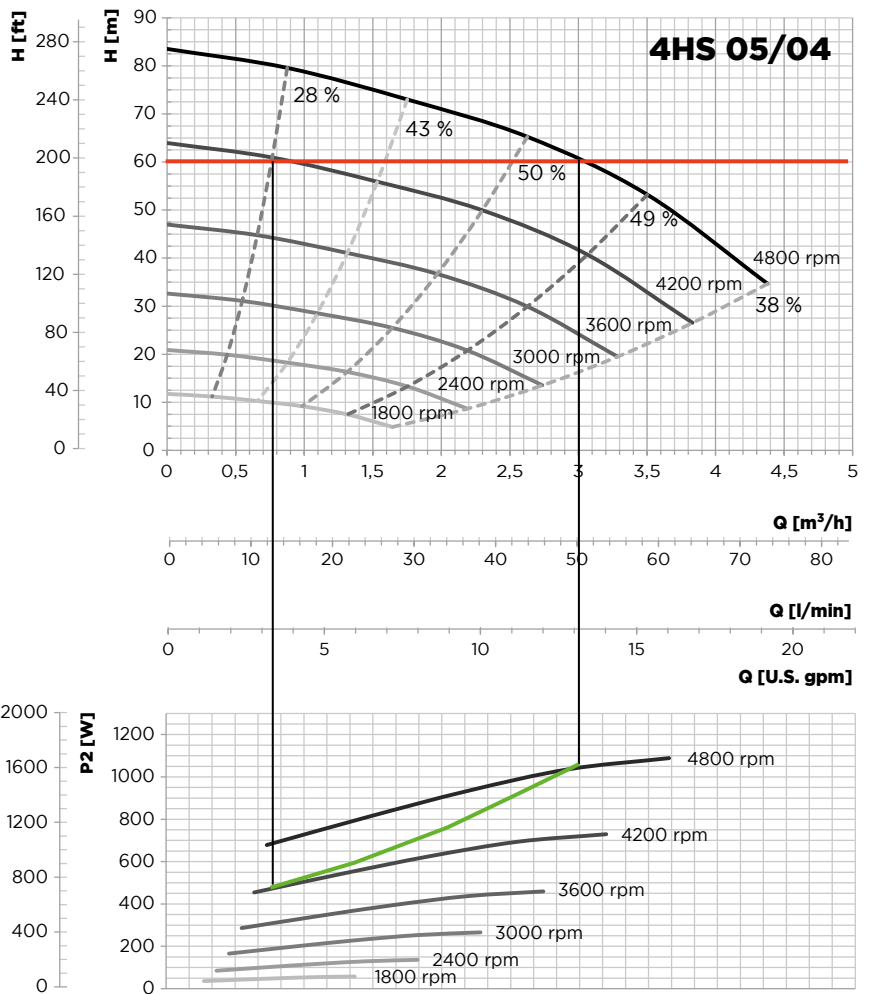
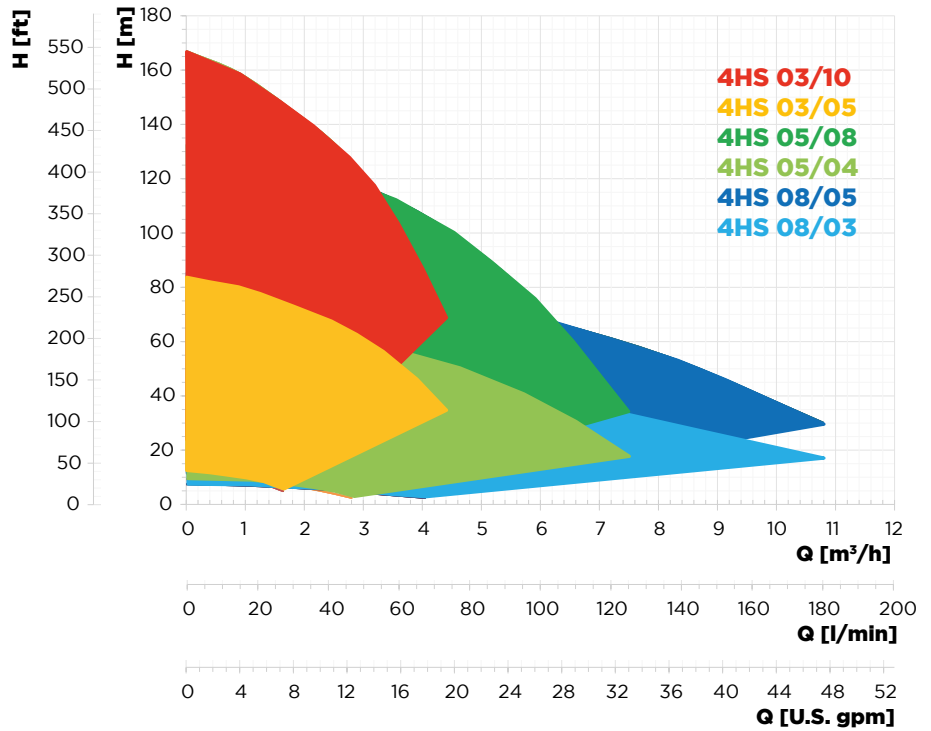

# Materials

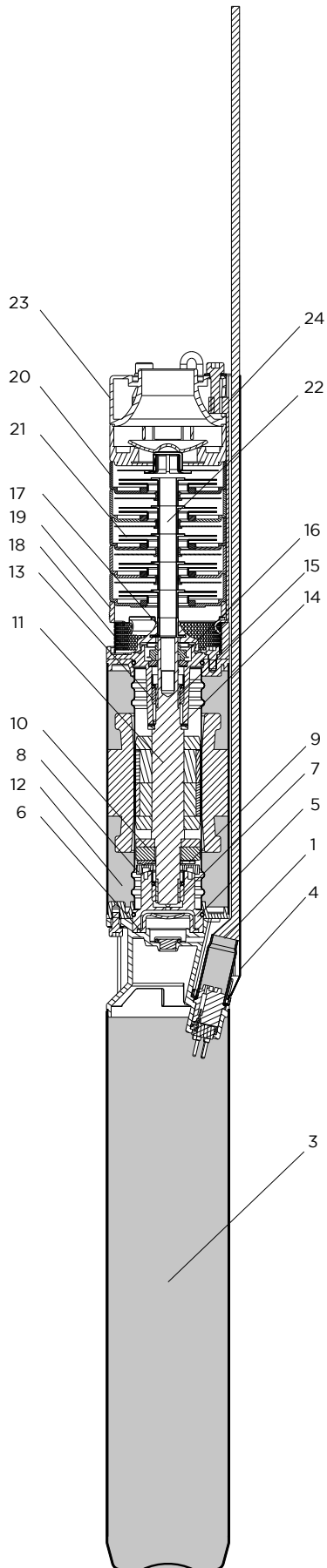

Ref	Description	Material
1	Power supply cable with removable connector for drinking water applications	AISI 304 + ACS-KTM-WRAS compliant
3	MINT: Electronic Integrated Module	
4	Cable guard	AISI 304
5	Lower thrust bearing	AISI 304
6	Rubber diaphragm	EPDM
7	Lower bush	SiC
8	Tilting disc	AISI 304
9	Pads	AISI420j
10	Carbon disc	CTI25
11	Shaft with rotor	AISI 431
12	Canned type stator	AISI 304
13	Upper bush	SiC
14	Upper thrust bearing	Teflon
15	Ceramized sleeve	AISI 304 + Ceramic
16	Mechanical seal	SiC
17	Rotating sandguard	NBR
18	Pump filter	AISI 304
19	Pump bracket	AISI 304
<b>Centrifugal pump</b>		
20	Diffusers	AISI 304
21	Impellers	AISI 304
22	Pump shaft	AISI 304
23	Discharge	AISI 304
24	Straps	AISI 304

# Performance

## 4HS 03/05

Technical specifications	
<b>Rated input voltage</b>	1 x 190 - 265 VAC
<b>Max input current</b>	9.5 A
<b>Power factor</b>	1
<b>Max. input power</b>	1800 W
<b>Length</b>	900 mm
<b>Delivery</b>	1 1/4"
<b>Pump weight</b>	19.7 Kg
<b>Max diameter</b>	99 mm*
<b>Packing size</b>	120x20x29 cm
<b>Packing weight</b>	21.2 Kg

\* Max external diameter including cable and cable cover

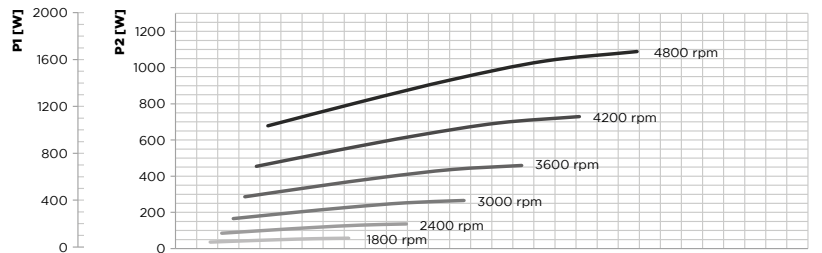
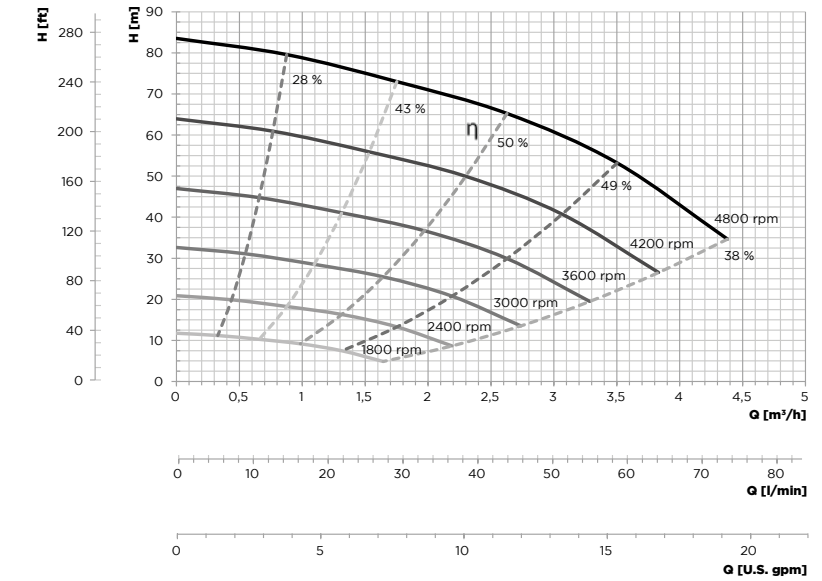

## 4HS 03/10

Technical specifications	
<b>Rated input voltage</b>	1 x 190 - 265 VAC
<b>Max input current</b>	16 A
<b>Power factor</b>	1
<b>Max input power</b>	3200 W
<b>Length</b>	1055 mm
<b>Discharge</b>	1 1/4"
<b>Pump weight</b>	22.2 Kg
<b>Max diameter</b>	99 mm*
<b>Packing size</b>	120x20x29 cm
<b>Packing weight</b>	23.2 Kg

\* Max external diameter including cable and cable cover

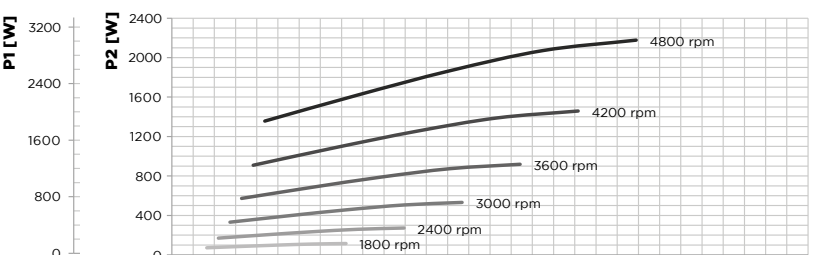
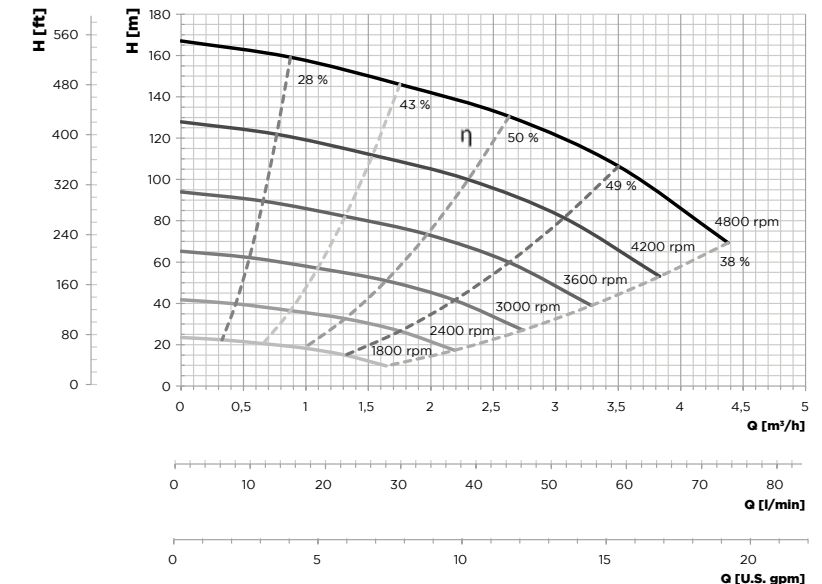



# Performance

## 4HS 05/04

Technical specifications	
<b>Rated input voltage</b>	1 x 190 - 265 VAC
<b>Max input current</b>	9.5 A
<b>Power factor</b>	1
<b>Max input power</b>	1800 W
<b>Length</b>	879 mm
<b>Discharge</b>	1 1/2"
<b>Pump weight</b>	19.5 Kg
<b>Max diameter</b>	99 mm*
<b>Packing size</b>	120x20x29 cm
<b>Packing weight</b>	21 Kg

\* Max external diameter including cable and cable cover

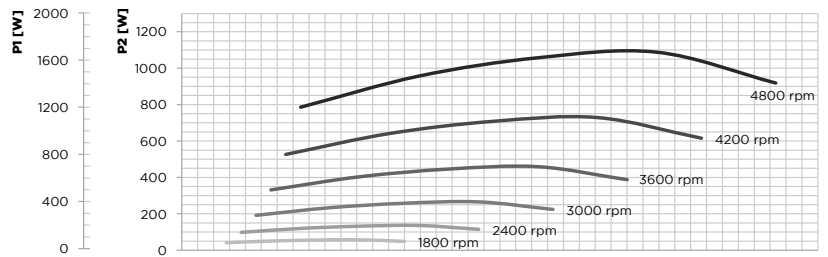
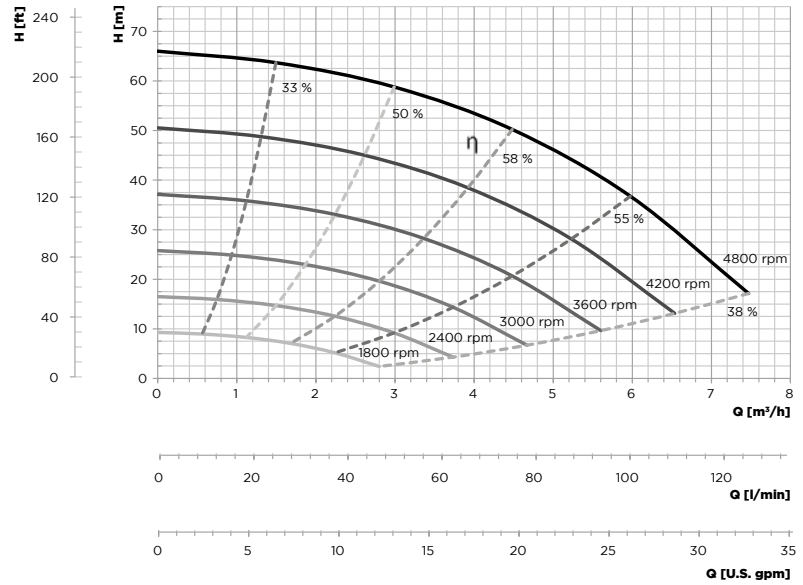

## 4HS 05/08

Technical specifications	
<b>Rated input voltage</b>	1 x 190 - 265 VAC
<b>Max input current</b>	16 A
<b>Power factor</b>	1
<b>Max input power</b>	3200 W
<b>Length</b>	1013 mm
<b>Discharge</b>	1 1/2"
<b>Pump weight</b>	22 Kg
<b>Max diameter</b>	99 mm*
<b>Packing size</b>	120x20x29 cm
<b>Packing weight</b>	23 Kg

\* Max external diameter including cable and cable cover

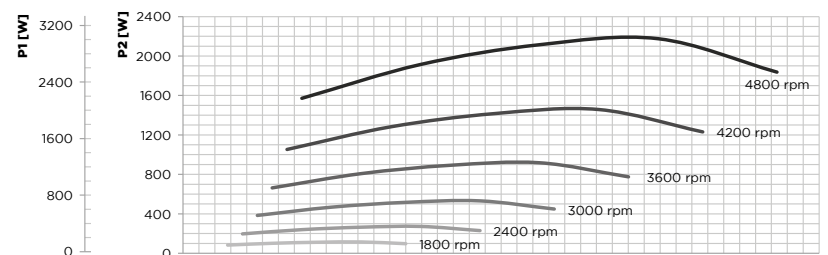
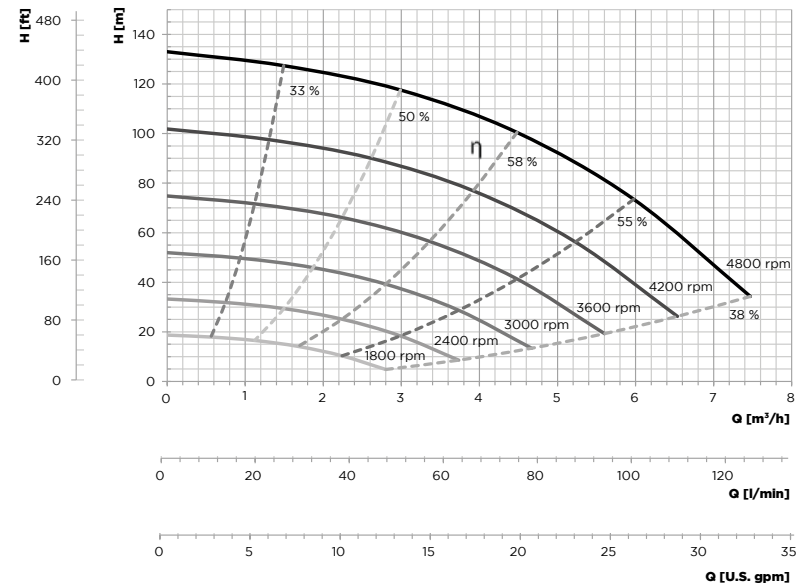

# Performance

## 4HS 08/03

Technical specifications	
<b>Rated input voltage</b>	1 x 190 - 265 VAC
<b>Max input current</b>	9.5 A
<b>Power factor</b>	1
<b>Max input power</b>	1800 W
<b>Length</b>	858 mm
<b>Discharge</b>	1 1/2" or 2"
<b>Pump weight</b>	19.4 Kg
<b>Max diameter</b>	99 mm*
<b>Packing size</b>	120x20x29 cm
<b>Packing weight</b>	21 Kg

\* Max external diameter including cable and cable cover

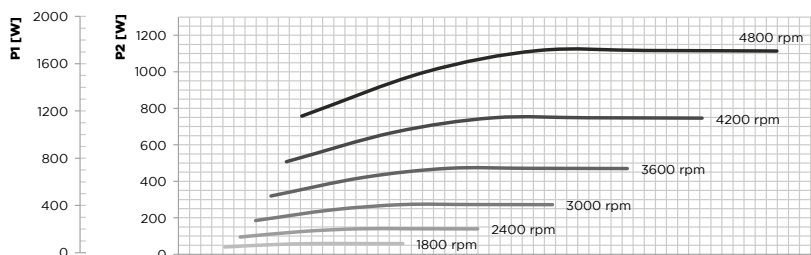
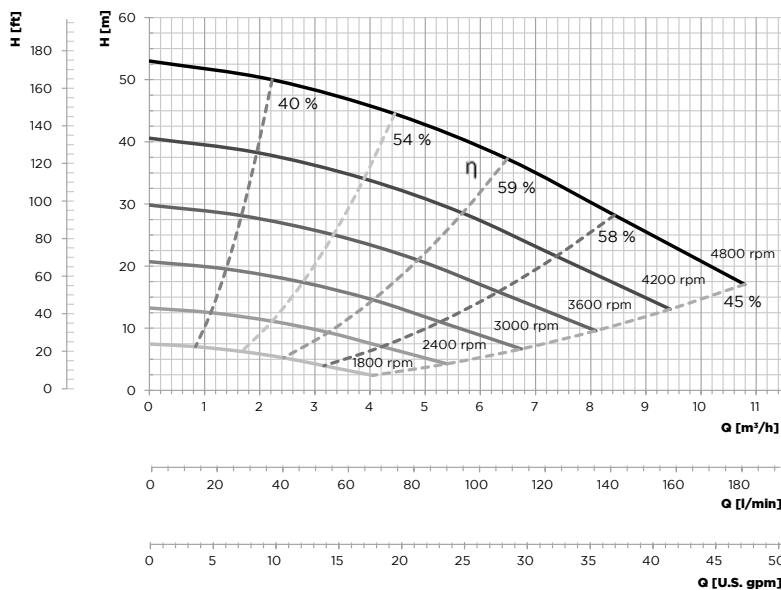

## 4HS 08/05

Technical specifications	
<b>Rated input voltage</b>	1 x 190 - 265 VAC
<b>Max input current</b>	9.5 A
<b>Power factor</b>	1
<b>Max input power</b>	3200 W
<b>Length</b>	950 mm
<b>Discharge</b>	1 1/2" or 2"
<b>Pump weight</b>	21 Kg
<b>Max diameter</b>	99 mm*
<b>Packing size</b>	120x20x29 cm
<b>Packing weight</b>	22 Kg

\* Max external diameter including cable and cable cover

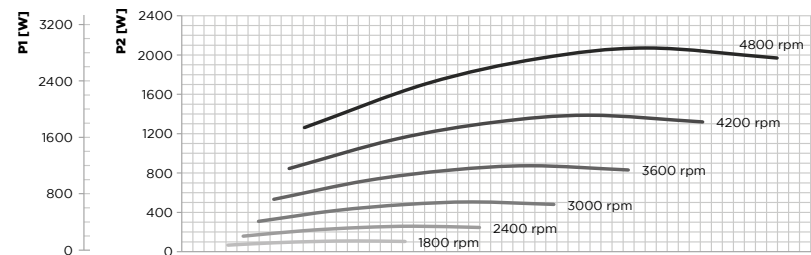
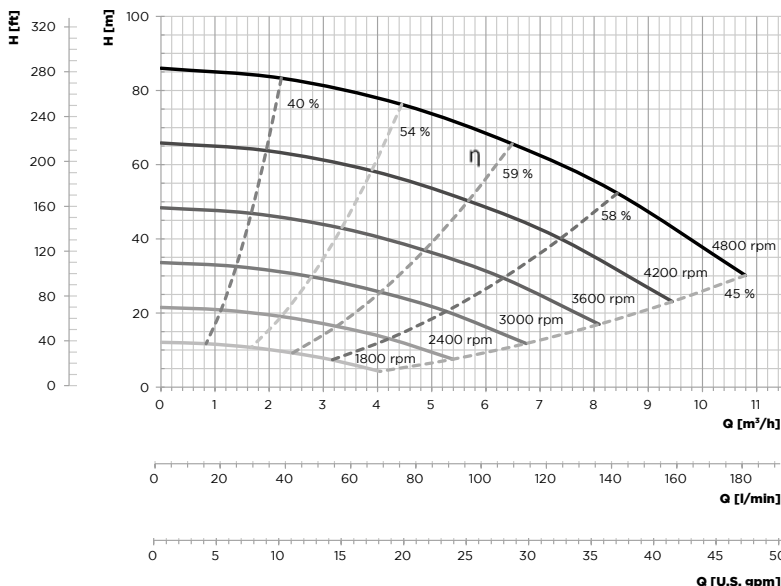

# General specifications

4HS Pump	
Max liquid temperature	35 °C (92°F)
Min liquid cooling speed	0.2 m/s
Characteristics of the pumped liquid	clean, chemically not aggressive, not explosive, without solid and fibre content, with max 50 g/m <sup>3</sup> sand content
Protection grade	IP68
Rubber diaphragm	150 m
Materials	Motor, impeller and diffuser in AISI 304 stainless steel
Cable	Flat cable ACS - WRAS - KTM approved
CM Control Module	
Max ambient temperature	50°C (122°F)
Protection grade	IP55 (Nema 4)
Materials	Aluminium enclosure, PVC labels, cable gland in polyamide (PA), display membrane in polyester (PE)
Analogue input	2 inputs 4-20 mA + 2 input 4-20 mA or 0-10 V settable by the user
Digital input	4 input N.O or N.C settable by the user
Digital output	2 relays output 5 A, 250 VAC, N.O or N.C settable by the user
User display	display LCD backlit, 16 characters x 2 rows, 5 buttons, buzzer for acoustic alarm
Shortcircuit protection	fuse

Certifications
CE

4HS pump can be installed both vertically and horizontally, as long as the outlet is never lower than the horizontal axis.

To ensure proper cooling if 4HS is not installed in a 4" well, it is necessary to use a cooling sleeve.

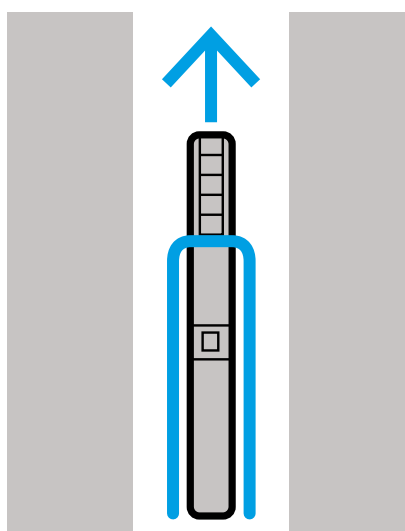
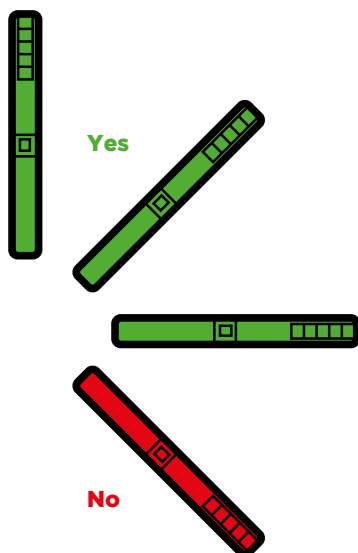

**Nastec srl**

Via della Tecnica 8  
36048 Barbarano Mossano  
Vicenza - Italy

tel +39 0444 886289  
fax+39 0444 776099  
info@nastec.eu

**nastec.eu**

