

Installation and use manual

SUND



Index

1. Introduction	3
2. Safety Instructions	4
3. Technical Characteristics	5
3.1 Performance	5
3.2 Weight and dimensions	6
3.3 Cable entries	6
4. Installation	6
4.1 Hydraulic connections.....	6
4.1.1 Priming	6
4.2 Electric connections	7
4.2.1 Protections	10
4.2.2 Electromagnetic compliance	10
5. Use and programming	11
5.1 Monitoring and programming.....	12
5.1.1 Monitoring	12
5.1.2 Programming.....	13
6. Protections and alarms	19

1. Introduction

SUND is a range of solar pumps for the circulation and filtering of pool water. It guarantees:

- Energy saving thanks to photovoltaic energy supply and variable-speed operation.
- Quick return on investment.
- Lengthening of system life and greater system reliability.
- Quick and simplified installation thanks to the electronics integrated into the motor and smartphone control.
- Extremely low noise operation.
- Installation in humid and dusty environments thanks to IP55 (NEMA 4) protection rating.

In the application with photovoltaic panels, the MPPT algorithm maximizes, for various conditions of irradiation and temperature, the electric power obtained from the panels thus the amount of pumped water. Pump speed is adjusted in relation to solar irradiation. When solar irradiation increases, pump will run faster thus pumping more water. When solar irradiation decreases (clouds moving or early/late hours of the day) pump will reduce its frequency and so delivery but it continues pumping till solar irradiation reaches the minimum value necessary for working.

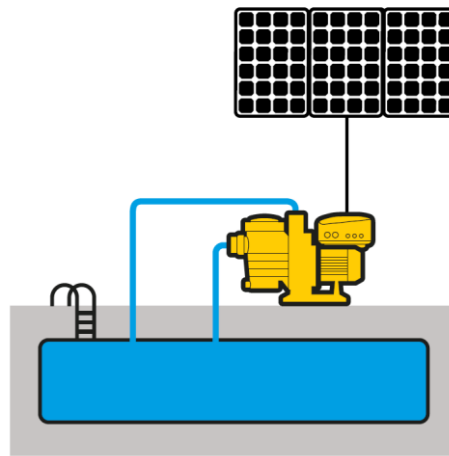

SUND is powered by solar panels or, if necessary, by mains supply. In this way, the pump's operation is guaranteed at any time of day. It is also possible to meet demand peaks through mains power in order to avoid the over-dimensioning of the photovoltaic system.

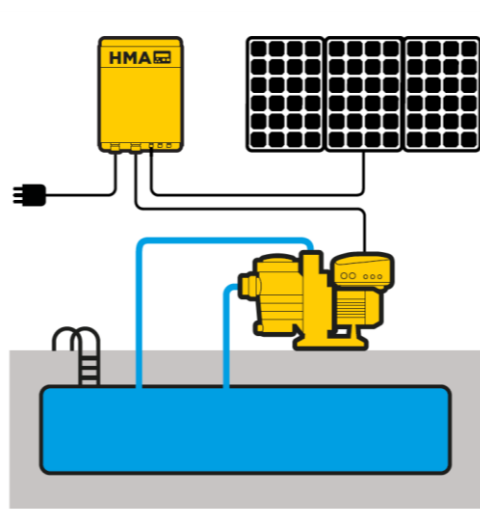

When installed, the HMA accessory automatically manages the switch from one source of energy to the other based on multiple logics that the user can select:

- radiation level
- time of day
- achievement of the daily flow requirement
- remote control via
- digital input.



2. Safety Instructions

The manufacturer strongly suggests carefully reading this operation manual before using and installing its products. Any operation (installation, maintenance and repair) must be carried out by trained, skilled, and qualified personnel. Failure to observe and follow the instructions in this manual may result in dangerous and potentially lethal results. Pay attention to all standard safety and accident prevention regulations.

 	<p>The device must be connected to power supply via a switch to ensure the complete disconnection from the power supply before any operation on the device itself (including visual inspection).</p> <p>Disconnect the device from the power supply before commencing any work.</p> <p>Do not disassemble for any reason the device without having first disconnected the device from the power supply and having waited at least 5 minutes.</p> <p>The device and pumping system must be grounded properly before operation.</p> <p>For the entire period the device is powered, high voltage is present on the output terminals of the inverter part whether or not the pump is running.</p> <p>Tightening all the screws on the cover with washers is recommended before powering the device. Otherwise, there may be a failure to connect the cover to ground, creating the risk of electric shock or even death.</p> <p>When powering the device with both PV panels (DC) and grid or generator (AC) it is necessary to connect only one power source (AC or DC) at a time, to switch between AC and DC power supply through an AC / DC switch, to install protections on both the AC and DC side in accordance with local regulations.</p> <p>The pump must operate only if completely filled with water. Failure to do so may result in severe damage to the pump itself with consequent expiry of the warranty.</p> <p>The installation must be in a dry, well - ventilated place, protected from access by unauthorized persons (including children) and from direct exposure to the sun and atmospheric agents.</p> <p>The pump can contain traces of water used for the final tests of the product. Before putting into service, it is recommended to wash with fresh water. Do not use solvents or other chemicals for cleaning any part of the product.</p> <p>In the case of long periods of inactivity, it is recommended to completely empty the pump to avoid blocking and freezing of the hydraulic part.</p> <p>Inspect the pump and the suction filter periodically (at least once a year).</p> <p>During operation some parts of the pump can reach temperatures above 40 ° C (104 ° F). Avoid contact with flammable products and always ensure proper ventilation.</p> <p>The pump is designed to work only with fresh or salty water free of solid particles and fibers, with a maximum sand content of 50 g/m3.</p> <p>During operation the pump produces a strong suction that can trap people (especially children) causing severe physical damage or even death.</p> <p>To reduce these risks, it is recommended to install the pump and the system according to local regulations and check the correct functioning of the grilles that protect the suction points.</p> <p>Do not loosen, unscrew or open the filter cover for any reason while the pump is running. If the pump is installed below the water level, close the intake valve before opening the filter cover.</p> <p>Failure to comply with these recommendations can result in severe damages or even death.</p>
--	---

Avoid any shock or significant impact during transport.

Check the product immediately upon delivery and check for damage and/or missing parts. If either occurs, immediately notify the supplier.

Damages due to transport, incorrect installation, or improper use of the device will null and void the warranty.

Tampering or disassembly of any component will automatically void the warranty.

The manufacturer cannot be held responsible for any damages to people and/or property due to improper use of its products.



Devices marked with this symbol cannot be disposed of in household waste but must be disposed of at appropriate waste drop-off centres. It is recommended to contact the Waste Electrical and Electronic Equipment drop-off centres (WEEE) in the area.

If not disposed of properly, the product can have potential harmful effects on the environment and on human health due to certain substances present within. Illegal or incorrect disposal of the product is subject to serious administrative and/or criminal penalties.

3. Technical Characteristics

3.1 Performance

Model	Vin DC VDC	Vin AC VAC	P1 max W
SUND 50	90 - 400	1 x 90 - 265	800

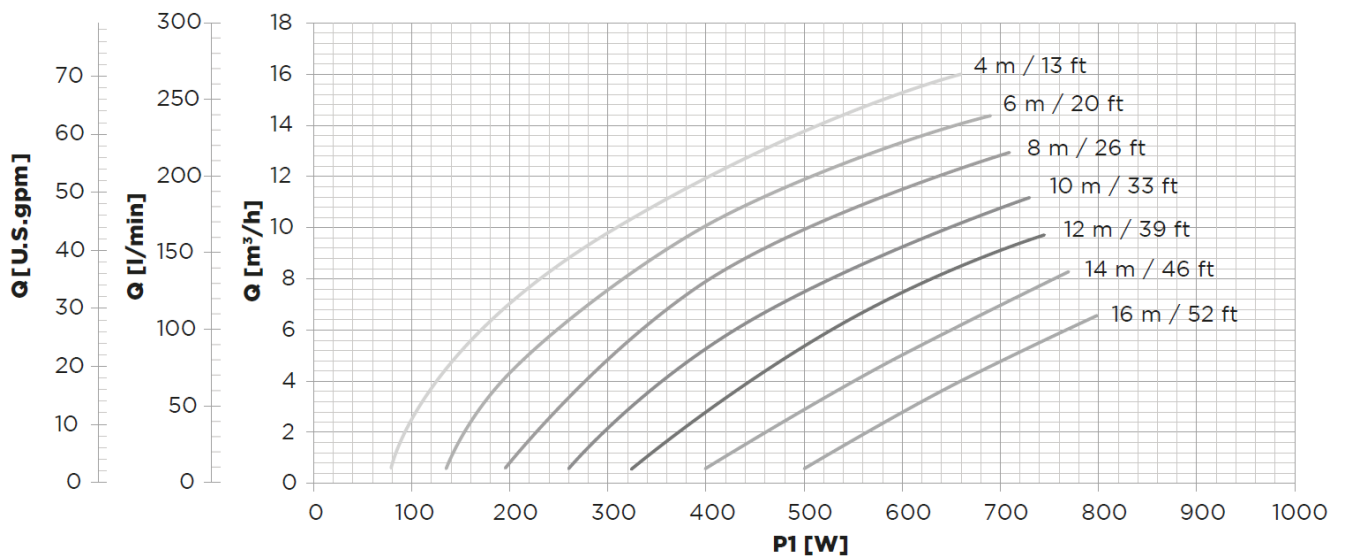

- P.F. line side (with AC power supply)
- Power supply frequency (with AC power supply): 50 - 60 Hz (+/- 2%)
- Stocking temperature: -30 to 70 °C (-22 to 158 °F)
- Max. ambient temperature: 50°C (122 °F)
- Max liquid temperature: 40 °C (104 °F)
- Max. altitude at rated load: 1000 m
- Max relative humidity: 95% without condensation
- Max working pressure: 3 bar
- Max suction head: 2,5 m
- Motor insulation class: F
- Grade of protection: IP55 (NEMA 4)*
- Connectivity: Bluetooth SMART communication for monitoring and programming, Modbus RTU RS485.

* Protect the device from direct exposure to sunlight and atmospheric agents

3.2 Weight and dimensions

Model	Net weight	Packing dimensions	Total weight
	kg	mm	kg
SUND 50	10,7	535x240x350(h)	11,4

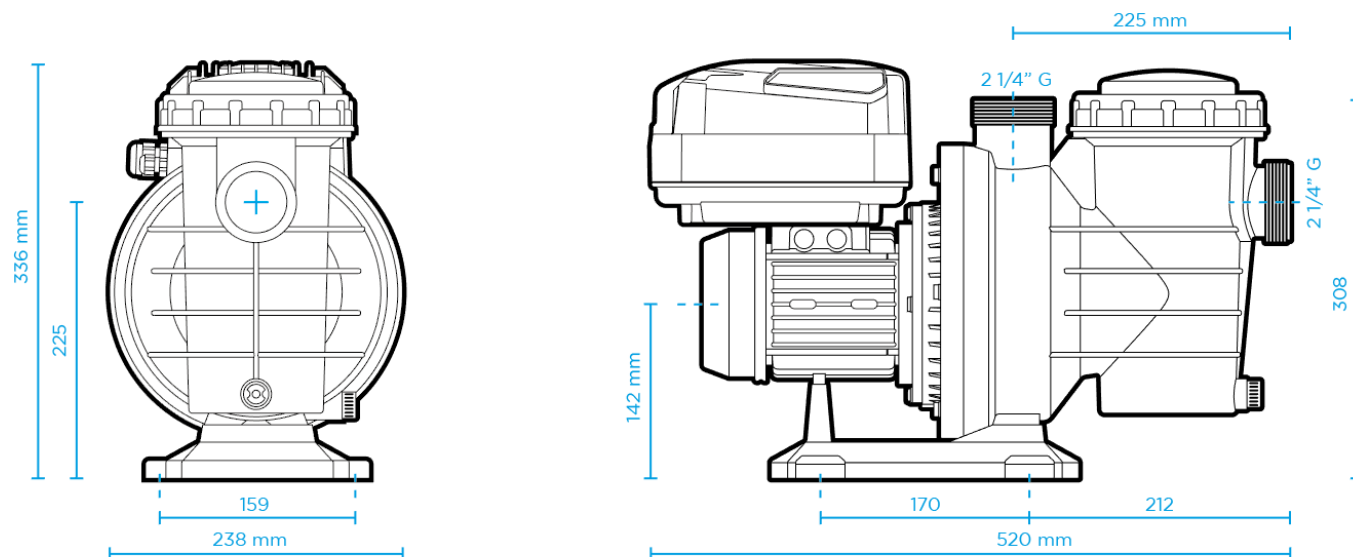

3.3 Cable entries

Model	M20 cable gland	M12 cable gland	EMC clips
SUND 50	1	3	3

Use the EMC clips to ground the signal cable shield.

4. Installation

4.1 Hydraulic connections

Install the pump in horizontal position on a strong base and raised from the ground (at least 10 cm).

Preferably use plastic pipes welded to the pump inlet and suction connections (external diameter 50 mm) using a suitable sealing adhesive.

The delivery and suction pipes must be correctly supported so as not to burden their weight on the pump connections.

4.1.1 Priming

In the case of installation under water level, fill the pump by slowly opening the valve in the suction line, keeping the outlet valve open to let the air out.

In the case of installation above water level, remove the cover and fill the pump by pouring water through the filter.

Verify that the pump is properly primed before starting it. Prolonged operation in non-primed condition can damage the pump itself.

4.2 Electric connections

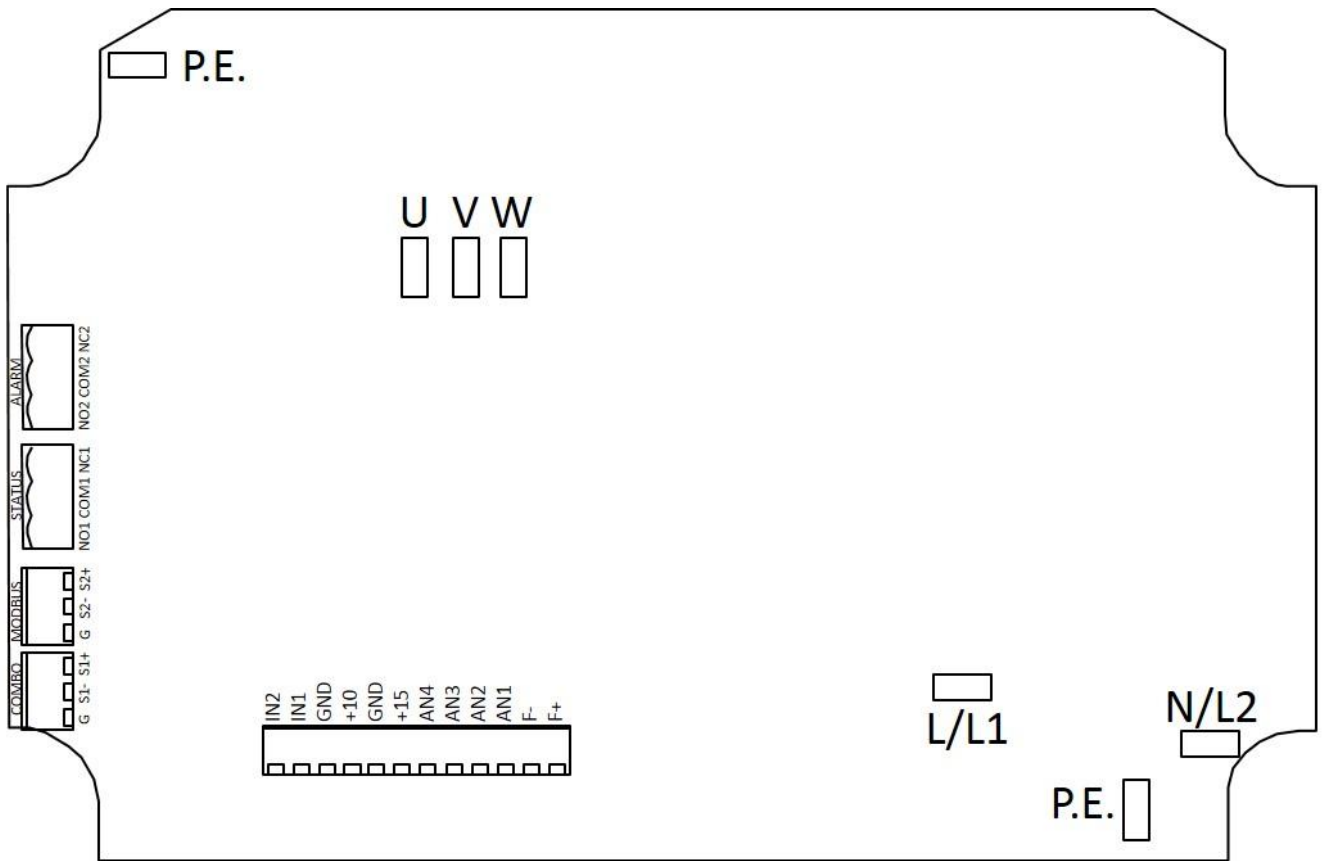

Power supply

- AC: L(L1), N(L2), P.E.
- DC: L(L1), N(L2), P.E.



In the case of DC power supply it is not necessary to respect the polarity.

Connect only one power source (AC or DC) at a time.

It is recommended to use pre-insulated female faston terminals 6,3x0,8 mm.

In order to respect limits of EN61800-3 Category C1 for irradiated disturbs, it is necessary to add a ferrite on input phases L and N. The ferrite and cabling instructions are available on request.

Recommended line cables stripping (without ferrite)

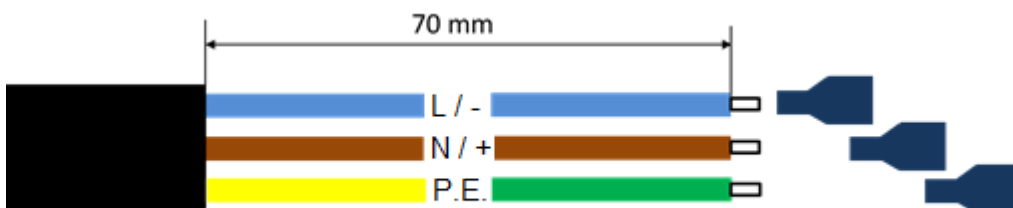

Motor output

- U (red), V (black), W (blue), P.E.



Respect the correspondence of colors and phases to ensure the correct rotation sense.

Failure to comply with this recommendation will result in a drastic reduction in performance and possible damage to the pump itself.

Analog inputs (sensors)

- AN1: 4-20 mA, sensor 1
- AN2: 4-20 mA, sensor 2
- AN3: 0-10 V, external set
- AN4: 0-10 V, trimmer for frequency regulation or external set 2
- +10
- +15

It is recommended to use pre-insulated ferrules.

Use shielded signal cables by placing the screen at one end using the provided EMC clips.

Follow the below figures for correct cable stripping and EMC clip assembling.

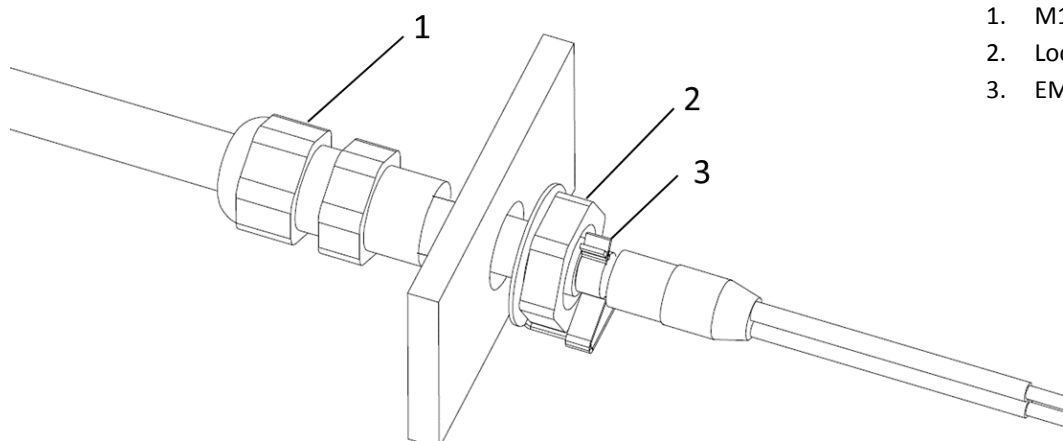
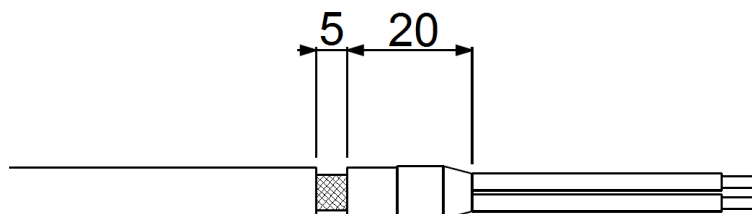

1. M12 cable gland
2. Locknut
3. EMC clip

Digital inputs

- **IN1 : motor start / stop**
- **IN2 : motor start / stop or set value 1 - 2 switching***

* only when “control mode: constant value 2 values” is selected.

It is recommended to use only volt free contacts.

Digital inputs can be configured as Normally Open or Normally Closed by software. Read programming chapter.

It is recommended to use pre-insulated ferrules.

Use shielded signal cables by placing the screen at one end using the provided EMC clips.

Digital outputs

- **NO1, COM1 : motor status, closed contact with motor running.**
- **NC1, COM1: motor status, closed contact with motor stopped.**
- **NO2, COM2: alarm status, closed contact without alarm.**
- **NC2, COM2: alarm status, closed contact with alarm or no power supply.**

Relays are volt free contacts. Max. voltage to the contacts is 250 V with max current 5 A.

It is recommended to use pre-insulated ferrules.

Use shielded signal cables by placing the screen at one end using the provided EMC clips.

COMBO serial:

- **S1+, S1-, G**

It is recommended to respect the polarity.

It is recommended to use pre-insulated ferrules.

Use shielded signal cables by placing the screen at one end using the provided EMC clips.

MODBUS RTU serial:

- **S2+, S2-, G**

It is recommended to respect the polarity.

It is recommended to use pre-insulated ferrules.

Use shielded signal cables by placing the screen at one end using the provided EMC clips.

4.2.1 Protections

The necessary protections depend on the type of installation and the local regulations.

In the case of both DC and AC power supply, it is necessary to provide the safety protections for both DC side and AC side. For the DC side it is recommended to use a DC switch with current protection (fuses) and surge protection (surge arrester).

For the AC side, it is advisable to use a fuse or circuit breaker protection with a characteristic curve of type C and a type B residual current device, sensitive to both AC and DC current.

4.2.2 Electromagnetic compliance







To ensure electromagnetic compatibility (EMC) of the system, it is necessary to apply the following measures:

- Always connect the device to ground.
- Use shielded signal cables by placing the screen at one end using the EMC clips.
- Use motor cable as short as possible (<1 m / <3 ft). For longer lengths, it is recommended to use shielded cables connecting the screen at both ends.
- Separate signal, motor, and power supply cables.

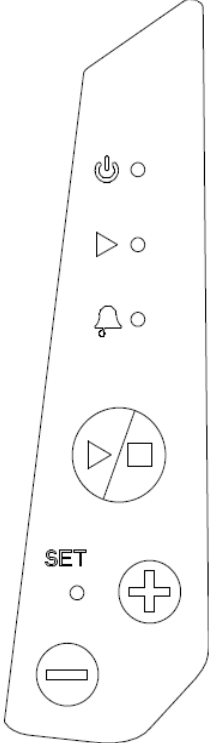
In order to respect limits of EN61800-3 Category C1 for irradiated disturbs, it is necessary to add a ferrite on input phases L and N. The ferrite and cabling instructions are available on request.

5. Use and programming

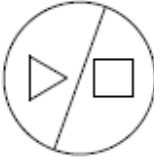
The pump can be operated in a basic way through the included keyboard.

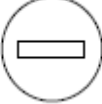
		Stand-by red led	<p>Red led ON: unit is powered with correct input voltage</p> <p>Blinking red led: undervoltage</p>
		Motor running green led	<p>Green led ON: motor is running</p> <p>Green led OFF: motor is stopped</p> <p>When the units is on “constant value” control mode, the green led blinks with higher frequency as much as the measured value is next to set value. If measured value is the same as set value, the green led is steady.</p>
		Alarm yellow led	Yellow led blinks with frequency which depends on alarm type. See “Alarms” chapter.
		Motor start and stop button	<p>Motor start and stop.</p> <p>If the unit is in alarm status, it is possible to try resetting the alarm by pressing the button two times.</p>
		SET green led	<p>Green led is ON when it’s possible to modify the set value (constant value mode) or the set frequency (fix frequency mode). Keep pressed the Up button or the Down button more than 5 seconds in order to enable the set adjusting.</p> <p>If the SET led is off, it is not possible to change the set value.</p> <p>When two or more units are in COMBO mode, the SET led blinks only on master unit. In this way it is possible to understand which unit in the group is the master and thus act on it to start and stop the system.</p> <p>Green led blinks fast when the unit is connected to smartphone and remotely controlled by the App.</p>
		Up button	<p>Through the UP button is possible to increase the set value (constant value mode) or the set frequency (fix frequency mode).</p> <p>In order to allow set changing it is necessary to keep pressed the UP button or the DOWN button more than 5 seconds till the green SET led becomes ON.</p>
		Down button	<p>Through the DOWN button is possible to reduce the set value (constant value mode) or the set frequency (fix frequency mode).</p> <p>In order to allow set changing it is necessary to keep pressed the UP button or the DOWN button more than 5 seconds till the green SET led becomes ON.</p>

5.1 Monitoring and programming

In order to access to parameters monitoring and programming it is necessary to use a smartphone or tablet with Bluetooth 4.0 (BTLE) and Nastec NOW App installed. The App is available on Android or iOS and can be downloaded free of charge through the on-line stores.

It is possible to disable the BTLE connection by removing power supply, wait at least 30 seconds till the red STAND-BY led is OFF, keep pressed together START/STOP button and DOWN button and give power supply. Release the buttons after 5 seconds.

It is then possible to enable the BTLE connection by removing power supply, wait at least 30 seconds till the red STAND-BY led is OFF, keep pressed together START/STOP button and UP button and give power supply. Release the buttons after 5 seconds.

Through the App it is possible to:

- Monitor multiple operating parameters simultaneously.
- Get statistics of energy consumption and check alarms history.
- Perform reports with the possibility to insert notes, images and email them or keep them into the digital archive.
- Make programs, save them in the archive, copy them to other devices and share them among multiple users.
- Remotely control, via wi-fi or GSM, a device, using a smartphone nearby as a modem.
- Access to manuals and additional documentation.
- Have on-line help on parameters and alarms details.

5.1.1 Monitoring

Following parameters can be monitored through the App in “Monitor” selection.

Actual value [bar]	Actual value is the value read by the sensor.
Set value [bar]	Set value is the value which has to be kept constant.
Frequency [Hz]	Motor running frequency.
Voltage Bus DC [V]	DC voltage on capacitor bus.
Motor current [A]	Phase current absorbed by the motor.
Motor power factor	Motor cosphi (P.F.).
Power [W]	Electrical power absorbed by the motor.
Module temperature [°C]	IGBT module temperature.
PCB temperature [°C]	Printed circuit board temperature.
Inverter hours [h]	Total inverter hours.
Motor hours [h]	Total motor running hours.
Address	Unit address when in COMBO mode.
ALARM HISTORY	Record of last 8 alarms.

5.1.2 Programming

Parameters are organized in four main menus: CONTROL, MOTOR, IN/OUT, CONNECT.

Parameters are password protected in 2 levels of access:

- **Installer level (CONTROL, IN/OUT). Password: 001**
- **Advanced level (MOTOR, CONNECT). Password: 002**

IN/OUT PARAMETERS

Parameter	Default	Description
Unit XXXXX	bar	Unit [bar,%,ft,in,cm,m,K,F,C,gpm,l/min,m3/h,atm,psi]
F. scale sensor XXX.X	16	Sensor full scale.
Min.value sensor XXX.X	0	Sensor minimum value.
Offset input 1 [%]	20%	Zero correction for analog input 1 (4-20 mA) (20 mA x 20% = 4 mA).
Offset input 2 [%]	20%	Zero correction for analog input 2 (4-20 mA) (20 mA x 20% = 4 mA).
Offset input 3 [%]	0%	Zero correction for analog input 3 (0-10V) (10V x 00% = 0 V).
Offset input 4 [%]	0%	Zero correction for analog input 4 (0-10V) (10V x 00% = 0 V).
AN1,AN2 function XXXXXX	Independent	Function logic for analog input AN1,AN2 (independent, lower value, higher value, difference 1-2).
Digital input 1 N.O. / N.C.	N.O.	By selecting N.O. (normally open) the inverter runs the motor if the digital input 1 is open; motor will be stopped if the digital input 1 is closed. By selecting N.C. (normally closed) the inverter runs the motor if the digital input 1 is closed; motor will be stopped if the digital input 1 is opened.
Digital input 2 N.O. / N.C.	N.O.	By selecting N.O. (normally open) the inverter runs the motor if the digital input 2 is open; motor will be stopped if the digital input 2 is closed. By selecting N.C. (normally closed) the inverter runs the motor if the digital input 2 is closed; motor will be stopped if the digital input 2 is opened.

Parameter	Default	Description
Dig. input 1 manual reset Enable / Disable	Disable	Enabling or disabling digital input 1 manual reset.
Dig. input 2 manual reset Enable / Disable	Disable	Enabling or disabling digital input 2 manual reset.
Dig.In.2 delay X [s]	3	Digital input IN2 delay. Digital input IN1 has 1 second fix delay.

CONTROL PARAMETERS

Parameter	Default	Description	MPPT	Constant value	Fix speed	Const.value 2 set	Fix speed 2 val.	External speed
Control mode <ul style="list-style-type: none"> MPPT Constant value Fix speed Const.value 2set Fix speed 2 val. External speed 	MPPT	<p>Mode of control:</p> <ul style="list-style-type: none"> MPPT: pump speed is adjusted in order to obtain maximum power available from PV panels. Constant value: the inverter changes the pump speed to keep the set value constant regardless water demand. Fix speed: the inverter feeds the pump at set frequency, so the pump speed is kept constant. Const. value 2 set: the two values are selected by opening or closing the digital input IN2. Fix speed 2 val: the two values are selected by opening or closing the digital input IN2. External speed: control motor frequency by using analogical input AN4. 						
Max alarm value XXX.X [bar]	10	Maximum value allowed in the system. If the readen value goes over this value, an alarm occurs and the pump is stopped. Pump is automatically restarted if the readen value goes below the maximum value for a period of at least 5 seconds.	✓	✓	✓	✓	✓	✓
Min alarm value XXX.X [bar]	0	Minimum value allowed in the system. If the readen value goes lower than this value, an alarm occurs and the pump is stopped. Pump is automatically restarted if the readen value goes higher than the minimum value for a period of at least 5 seconds.	✓	✓	✓	✓	✓	✓
Ext.set enabling ON/OFF	OFF	Enabling of set value changing by analog input AN3.		✓		✓		

Parameter	Default	Description	MPPT	Constant value	Fix speed	Const. value 2 set	Fix speed 2 val.	External speed
Set value XXX.X [bar]	3	Set value to be kept constant.	✓	✓		✓		
Compensation XXX.X [bar]	0	Value compensation at the maximum frequency for each pump. Acting on the green button you can reverse the sign.		✓				
Set value 2 XXX.X [bar]	3	Set value to be kept constant.				✓		
Compensation 2 XXX.X [bar]	0	Value compensation at the maximum frequency for each pump. Acting on the green button you can reverse the sign.				✓		
Set value update XX [s]	5	Time to update set value for compensation.		✓		✓		

To ensure proper operation of pressure control is recommended to place the sensor near the pump.
To compensate the pressure loss in the pipes (proportional to flow) it is possible to vary the pressure set in a linear relation with respect to frequency.

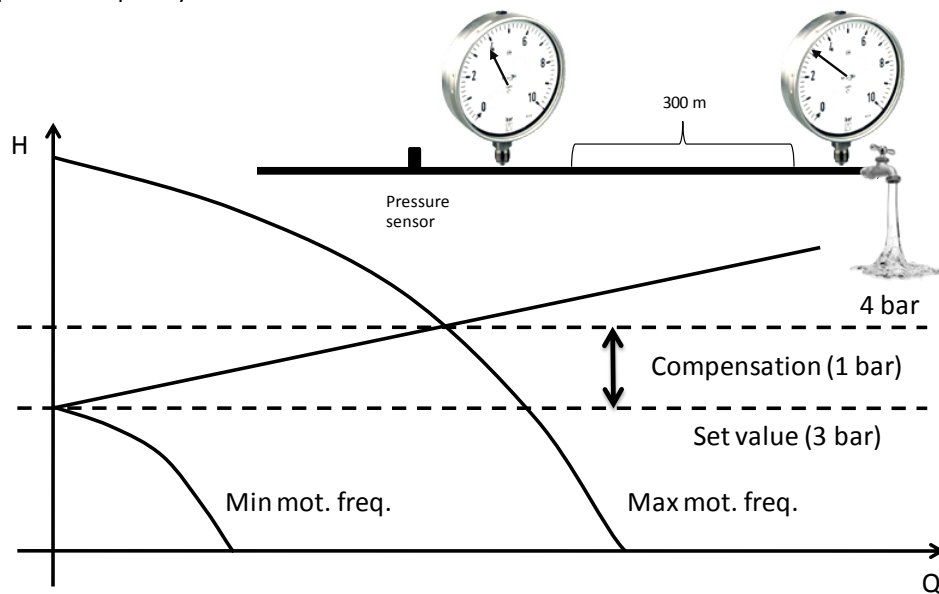

It can perform the following test to verify the correct value of compensation:

1. install a pressure gauge away from the pressure sensor
2. open completely the valve
3. check the pressure gauge

--> Set the value of *compensation*. equal to the difference of the values from the two gauges.

When using a group of pumps, the pressure compensation to be applied to each pump is equal to the total pressure compensation (when all the pumps are running at full speed) divided by the number of pumps in the group.

Operating freq. XXX [Hz]	50	Frequency value to feed the pump.			✓			
-----------------------------	----	-----------------------------------	--	--	---	--	--	--

Parameter	Default	Description	MPPT	Constant value	Fix speed	Const.value 2 set	Fix speed 2 val.	External speed
Operating freq. 2 XXX [Hz]	50	Frequency value to feed the pump.					✓	
Freq.min.control XXX [Hz]	50	Minimum frequency below which the pump tries to stop.		✓		✓		✓
Stop delay XX [s]	5	Delay for which the pump tries to stop below freq.min.control.		✓		✓		✓
Control ramp XXX.X [s]	20	Ramp time from freq.min.control to min.motor freq. If, during this time, the read value goes below the (set value - delta control), the inverter powers the motor again; otherwise, the inverter will stop the pump.		✓		✓		✓
Delta control XXX.X [bar]	0.1	Value drop below the set value required to restart the pump during control ramp.		✓		✓		

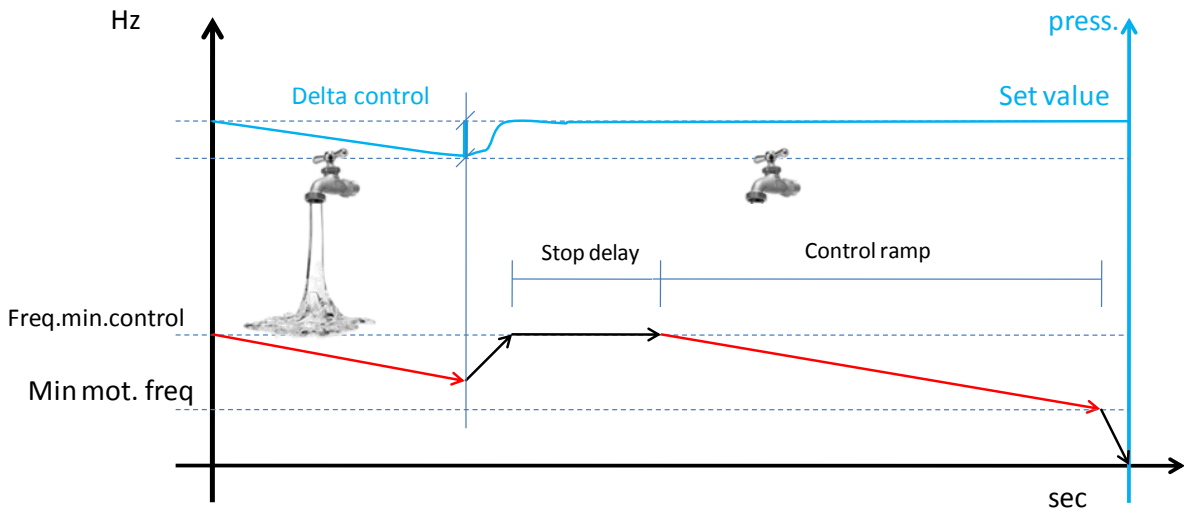

Delta start XXX.X [bar]	0.5	Value drop below the set value required to start the pump from stop condition.		✓		✓		
Delta stop XXX.X [bar]	0.5	Value increase respect to set value which must be passed so that there is a forced shutdown of the pump.		✓		✓		
MPPT: volt. gap dV = XX.X [V]	XX	MPPT voltage gap.	✓					
MPPT: time gap dt = XX.X [s]	XX	MPPT time gap.	✓					

Parameter	Default	Description	MPPT	Constant value	Fix speed	Const. value 2 set	Fix speed 2 val.	External speed
MPPT: freq. gap df = XX.X [Hz]	XX	MPPT frequency gap.	✓					
Ki		Kp and Ki parameters allow the dynamic control of system; set values are usually enough to get a valid dynamic control.	✓	✓		✓		
Kp								
COMBO ON/OFF	OFF	Enabling or disabling COMBO operation as described in COMBO chapter.		✓		✓		
Address XX	00	Inverter address: <ul style="list-style-type: none"> 00 master 01 to 07 slaves 		✓		✓		
Alternance ON/OFF	OFF	Function to allow alternating between the inverters connected in COMBO in order to allow equal use of each pump in the group; master will reorganize the starting priority of the pumps by checking the life of each of them.		✓		✓		
Alternance period XX [h]	0	Maximum difference in terms of hours between the pumps in the group. 0 stays for 5 minutes.		✓		✓		
COMBO synchrony ON/OFF	OFF	With this parameter it is possible to activate the synchronous operation (same speed) of the pumps in COMBO. It is however necessary to appropriately lower the parameter "f. min. control".		✓		✓		
Start delay AUX t = XX [s]	0	Delay time with which the slaves start after the variable speed pump has reached the maximum frequency and the pressure value has fallen below set value – delta control		✓		✓		
PI control Direct/Reverse	Direct	Direct: increasing motor speed also misured value increases Reverse: increasing motor speed, misured value decreases.		✓		✓		
Periodic autorun t = XX [h]	0	Pump periodic autorun after XX hours of inactivity. Value 0 makes function disabled. <u>Warning</u> , review the advice in chapter 1.		✓	✓	✓	✓	✓

Parameter	Default	Description	MPPT	Constant value	Fix speed	Const.value 2 set	Fix speed 2 val.	External speed
Dry run cosphi X.XX	0.65	Cosphi value below which the unit stops the motor and give "no water" alarm.	✓	✓	✓	✓	✓	✓
Restarts delay XX [min]	10	Restart delay after a dry running alarm. At each tentative (max 5) restart delay will be doubled.	✓	✓	✓	✓	✓	✓

MOTOR PARAMETERS

Parameters	Default	Description
Max motor freq. XXX [Hz]	50	Maximum motor frequency. Note: by reducing the maximum motor frequency, maximum current will be reduced as well.
Ramp up time XXX.X [sec]	4	Ramp-up time to reach the speed required to achieve the set pressure (or frequency value). Longer times delay the system reaching the preset value but better protect system components.
Ramp down time XXX.X [sec]	4	Ramp-down time to reach zero speed. Longer times keep the system pressurized, while protecting the system components.
Autorestart ON/OFF	OFF	If ON is selected, after a lack of voltage, the pump returns to its normal status; if the inverter was powering the pump before the voltage drop, it resumes powering the pump automatically. <u>Warning</u> , review the advice in chapter 1.

CONNECTIVITY PARAMETERS

Parameters	Default	Description
MODBUS address XXX	1	MODBUS address from 1 to 247
MODBUS baudrate XXXXX [bps]	9600	MODBUS baudrate from 1200 bps to 57600 bps
MODBUS data format XXXXX	RTU N81	MODBUS data format: RTU N81, RTU N82, RTU E81, ETU O81

6. Protections and alarms

ALARM MESSAGE	LED NOTIFICATION	ALARM DESCRIPTION	POSSIBLE SOLUTIONS
UNDER VOLTAGE	Red STAND-BY led blinking	Supply voltage too low	Check possible causes of undervoltage.
OVER VOLTAGE	Red STAND-BY led and yellow ALARM led blinking	Supply voltage too high	Check possible causes of overvoltage.
DRY RUN COSPHI	Yellow ALARM led 1 blink	Motor cosphi is lower than the set dry running cosphi.	<ul style="list-style-type: none"> • Check if the pump is primed. • Check the set dry running cosphi. Dry running cosphi is approximately 60% of the rated cosphi (at rated frequency) listed on the motor plate. <p>If pump's cosphi is lower than the set dry-running cosphi for at least 2 seconds, the inverter stops the pump. The inverter tries to run the pump every 10, 20, 40, 80, 160 minutes and then the pump is stopped.</p> <p>WARNING: if dry running protection occurs, the inverter will try to start the pump automatically. Be sure to cut power supply before performing any maintenance.</p>
OVERCURRENT MOT.	Yellow ALARM led 2 blinks	Motor overload: motor current is higher than the rated motor current setting parameter.	<p>Make sure that the motor current setting parameter is at least 5% higher than rated.</p> <p>Check other possible causes of over current.</p>
SENSOR FAULT	Yellow ALARM led 3 blinks	Sensor error	<ul style="list-style-type: none"> • Check the transducer • Check the wiring of transducer
OVER TEMP. INV.	Yellow ALARM led 4 blinks	Inverter over temperature	<ul style="list-style-type: none"> • Make sure that ambient temperature is less than 40 °C (104 °F). • Check if cooling fan is working properly and if mounting space is adequate for proper cooling.

IGBT TRIP ALARM	Yellow ALARM led 5 blinks	The current drawn by the load exceeds the capacity of the inverter or power module (IGBT) is failed.	<ul style="list-style-type: none"> • Decrease the ramp-up time • Check the voltage drop along the supply cable to the motor. • Check motor insulation
NO COMMUNICATION	Yellow ALARM led 6 blinks	Communication between master and slave(s) has been interrupted.	<ul style="list-style-type: none"> • Check the wiring connections
MAX. VALUE ALARM	Yellow ALARM led 7 blinks	Measured value has reached the maximum value accepted by the system.	<ul style="list-style-type: none"> • Check possible causes of reaching max value • Check the max alarm value setting
MIN. VALUE ALARM	Yellow ALARM led 8 blinks	Measured value has reached the lowest value accepted by the system.	<ul style="list-style-type: none"> • Check possible causes reaching min value (i.e. broken pipe, open pressure relief valve, etc.) • Check the min alarm value setting.
ADDRESS ERROR	Yellow ALARM led 9 blinks	Two units with master address in the group	<ul style="list-style-type: none"> • Check units address
ALARM CPU	Yellow ALARM led 10 blinks	Error on CPU	<ul style="list-style-type: none"> • Contact technical service
ACTIVE DIGITAL INPUT	Yellow ALARM led fast blinking	Digital input activated	<ul style="list-style-type: none"> • Check digital input connections.

EC DECLARATION OF CONFORMITY

In according with:

2014/53/EU Radio Equipment Directive (RED)

2011/65/EU - RoHS Directive

We, Nastec srl, via della Tecnica, 8, 36021, Barbarano Mossano, Vicenza, Italy, declare that:

SUND conforms to the following regulations:

EN 61000-6-3:2007 + A1:2011

EN 62233:2008

EN 61000-6-1:2007

EN 62311:2008

EN 61800-3:2004 + A1:2012

EN 60529:1991 + A1:2000 + A2:2013

ETSI EN 301 489-17 V3.1.1:2017

EN 60335-1:2012 + AC:2014 + A11:2014 + A13:2017

ETSI EN 301 489-1 V2.1.1:2017

EN 50581:2012

ETSI EN 300 328 V2.1.1:2016-11

EN 809:2009

EN 60335-2-41:2012

**Ing. Marco Nassuato
Operation Manager**



A series of 26 horizontal lines spanning the width of the page, intended for writing or drawing.

