

Operating manual

VASCO Solar



Index

1. VASCO Solar Introduction	3
2. Safety Instructions	5
3. Technical Characteristics	6
3.1 Weight and dimensions	7
4. Electric wiring	8
4.1 Protections	13
4.2 Electromagnetic compliance.....	13
4.3 Installation with long motor cables	13
5. VASCO Solar installation (Size 2)	14
6. PV system sizing	15
7. VASCO Solar Installation for constant pressure control	16
7.1.1 Pressure tank	16
7.1.2 Pressure sensor	17
8. VASCO Solar Use and Programming	17
8.1 VASCO Solar display	17
8.2 Initial configuration	18
8.2.1 FOC motor control	19
8.3 Initial view	21
8.4 Menu view.....	22
8.5 Control parameters	22
8.6 Motor parameters.....	26
8.7 IN/OUT parameters.....	29
8.8 Connectivity parameters.....	30
9. Protections and alarms	31

1. VASCO Solar Introduction

VASCO Solar Solar inverters come to power traditional pumping systems using photovoltaic energy.

In this way it's possible to convert old systems in renewable energy installations or to use the same AC pumps in the creation of independent, cost-saving and environmentally sustainable water systems.

VASCO Solar Solar is able to convert DC voltage coming from photovoltaic panels into AC voltage for powering any pump driven by three phase asynchronous motor.

MPPT (Maximum Power Point Tracking) maximizes, for various conditions of irradiation and temperature, the electrical power drawn from the panels so the amount of pumped water.

Pump speed is constantly adapted to available solar irradiation thus maximizing the amount of pumped water and making possible operation even in low irradiation conditions.

VASCO Solar also offers complete pump protection against over-voltage, over-current and dry running.

VASCO Solar can be used with any type of traditional AC pump thus offering maximum flexibility in several application areas.

In the use with submersible pumps, VASCO Solar allows to fill tanks for watering livestock or simply irrigate lawns or crops.

In the use with surface pumps, VASCO Solar can serve an irrigation fishing from a nearby water reserve or feed with no energy cost a pool pump.

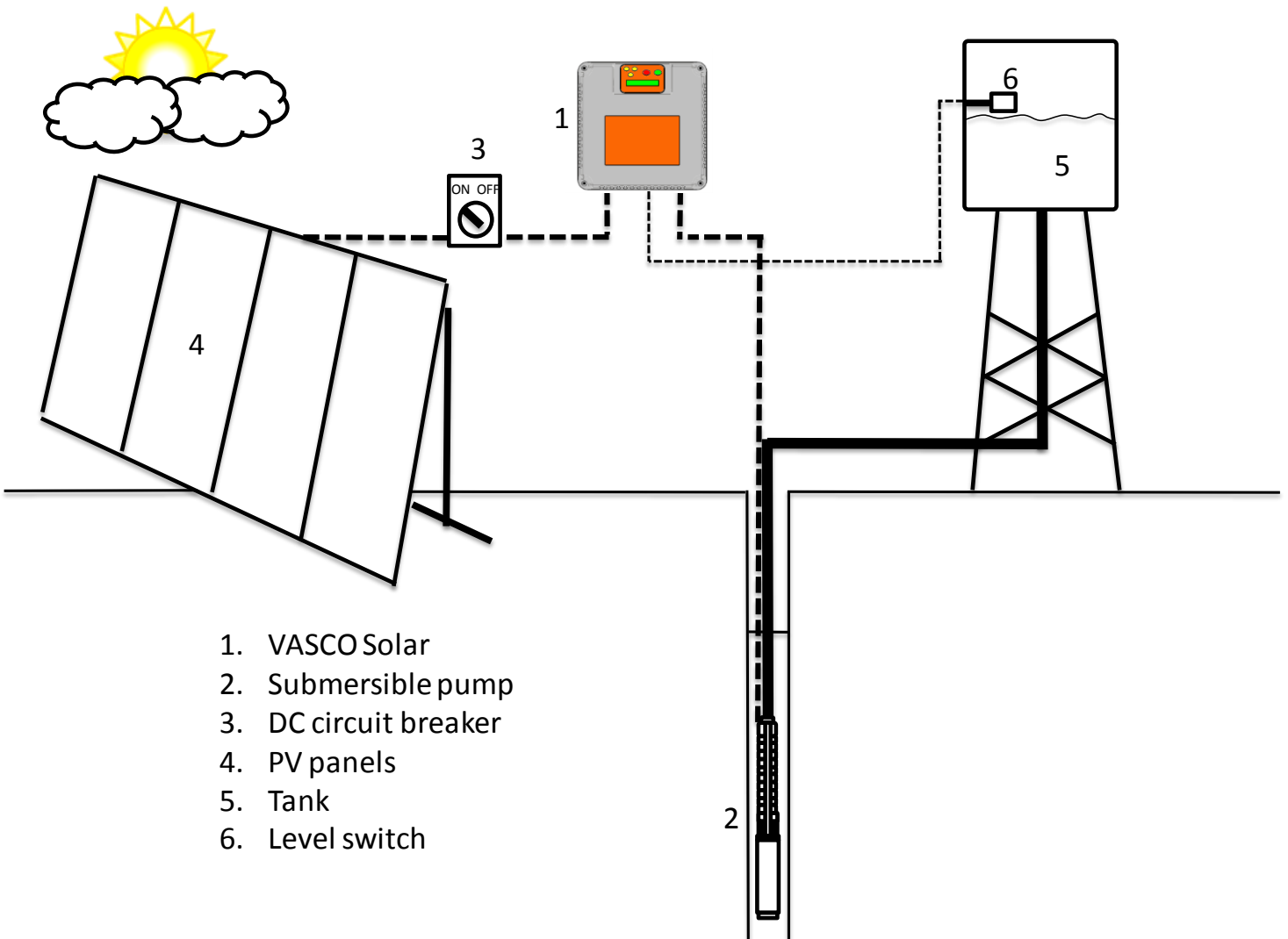

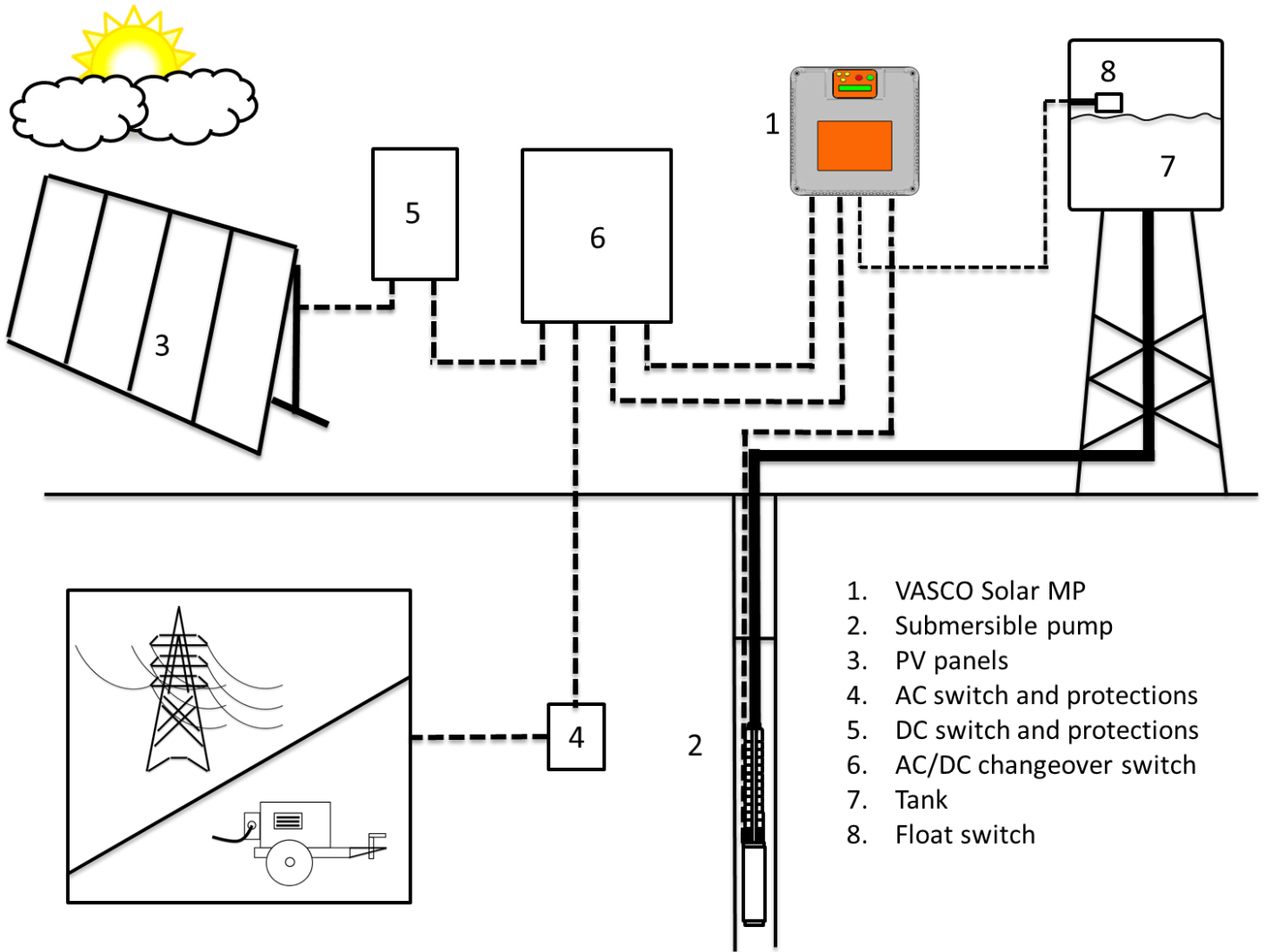

The MultiPower (MP) versions are able to be powered, when necessary, by alternating voltage (grid or generator).



1. VASCO Solar MP
2. Submersible pump
3. PV panels
4. AC switch and protections
5. DC switch and protections
6. AC/DC changeover switch
7. Tank
8. Float switch

2. Safety Instructions

The manufacturer strongly suggests carefully reading this operation manual before using and installing its products. Any operation (installation, maintenance and repair) must be carried out by trained, skilled, and qualified personnel. Failure to observe and follow the instructions in this manual may result in dangerous and potentially lethal electric shock. Pay attention to all standard safety and accident prevention regulations.

	<p>The device must be connected to main power supply via a switch to ensure the complete disconnection from the network before any operation on the VASCO Solar itself (including visual inspection) and/or on the connected load.</p> <p>Disconnect VASCO Solar from the power supply before commencing any work.</p> <p>Do not remove, for any reason, the cover and the cable plate without having first disconnected the device from the main power supply and having waited at least 5 minutes.</p> <p>VASCO Solar and pumping system must be grounded properly before operation. For the entire period VASCO Solar is powered, high voltage is present on the output terminals of the inverter whether or not the pump is running.</p> <p>Tightening all 4 screws on the cover with washers is recommended before powering the device. Otherwise, there may be a failure to connect the cover to ground, creating the risk of electric shock or even death.</p> <p>In the MultiPower (MP) models:</p> <ul style="list-style-type: none">• Protections must be used on both the AC and DC side.• Switching between AC and DC power supply must be done by an AC / DC switch in accordance with local regulations.• Connect only one power source (AC or DC) at a time.
	



Avoid any shock or significant impact during transport.

Check the VASCO Solar immediately upon delivery and check for damage and/or missing parts. If either occurs, immediately notify the supplier.

Damages due to transport, incorrect installation, or improper use of the device will null and void the warranty.

Tampering or disassembly of any component will automatically void the warranty.

The manufacturer cannot be held responsible for any damages to people and/or property due to improper use of its products.

 	<p>Devices marked with this symbol cannot be disposed of in household waste but must be disposed of at appropriate waste drop-off centres. It is recommended to contact the Waste Electrical and Electronic Equipment drop-off centres (WEEE) in the area. If not disposed of properly, the product can have potential harmful effects on the environment and on human health due to certain substances present within. Illegal or incorrect disposal of the product is subject to serious administrative and/or criminal penalties.</p>
--	---

3. Technical Characteristics

Model	Vin DC	Vin DC P1 nom*	Vin AC	Max Vout	Max I out	Motor power P2 **		Size
	[VDC]	[VDC]	[VAC]	[VAC]	[A]	[VAC]	[kW]	
VASCO Solar 212	160 – 650	> 320	-	3 x 250	12	3 x 230	2,2	2
VASCO Solar 409	320 – 850	> 560	-	3 x 460	9	3 x 400	3	2
VASCO Solar 412	320 – 850	> 560	-	3 x 460	12	3 x 400	4	2
VASCO Solar 415	320 – 850	> 560	-	3 x 460	15	3 x 400	5,5	2
VASCO Solar 418	320 – 850	> 560	-	3 x 460	18	3 x 400	7,5	2
VASCO Solar 425	320 – 850	> 560	-	3 x 460	25	3 x 400	11	2
VASCO Solar 430	320 – 850	> 560	-	3 x 460	30	3 x 400	15	2
VASCO Solar 438	320 – 850	> 560	-	3 x 460	38	3 x 400	18,5	3
VASCO Solar 448	320 – 850	> 560	-	3 x 460	48	3 x 400	22	3
VASCO Solar 465	320 – 850	> 560	-	3 x 460	65	3 x 400	30	3
VASCO Solar 485	320 – 850	> 560	-	3 x 460	85	3 x 400	37	3
VASCO Solar 212 MP	160 – 650	> 320	3 x 190 – 520	3 x 250	12	3 x 230	2,2	2
VASCO Solar 409 MP	320 – 850	> 560	3 x 190 – 520	3 x 460	9	3 x 400	3	2
VASCO Solar 412 MP	320 – 850	> 560	3 x 190 – 520	3 x 460	12	3 x 400	4	2
VASCO Solar 415 MP	320 – 850	> 560	3 x 190 – 520	3 x 460	15	3 x 400	5,5	2
VASCO Solar 418 MP	320 – 850	> 560	3 x 190 – 520	3 x 460	18	3 x 400	7,5	2
VASCO Solar 425 MP	320 – 850	> 560	3 x 190 – 520	3 x 460	25	3 x 400	11	2
VASCO Solar 430 MP	320 – 850	> 560	3 x 190 – 520	3 x 460	30	3 x 400	15	2
VASCO Solar 438 MP	320 – 850	> 560	3 x 190 – 520	3 x 460	38	3 x 400	18,5	3
VASCO Solar 448 MP	320 – 850	> 560	3 x 190 – 520	3 x 460	48	3 x 400	22	3
VASCO Solar 465 MP	320 – 850	> 560	3 x 190 – 520	3 x 460	65	3 x 400	30	3
VASCO Solar 485 MP	320 – 850	> 560	3 x 190 – 520	3 x 460	85	3 x 400	37	3

* Input voltage necessary to reach the maximum pump speed.

** Typical motor power. It is recommended to refer to the rated motor current when selecting the VASCO Solar model.

- Max ambient temperature at nominal current: 50°C (122 °F)
- Max. altitude at nominal current: 1000 m
- Grade of protection: IP65 (NEMA 4) (Size 2) , IP54 (NEMA 12) (Size 3)
- MODBUS RTU RS485, Bluetooth SMART.

* avoid direct exposition to solar rays.

VASCO Solar Solar is able to power the motor with a higher current for a short period of time according to the linear relation: 101% of the nominal current for 10min., 110% nominal current for 1 min.

3.1 Weight and dimensions

Model	Weight	Size
	[Kg]	
VASCO Solar 212	8,2	2
VASCO Solar 409	8,3	2
VASCO Solar 412	8,5	2
VASCO Solar 415	8,5	2
VASCO Solar 418	8,7	2
VASCO Solar 425	8,7	2
VASCO Solar 430	8,7	2
VASCO Solar 438	28	3
VASCO Solar 448	28	3
VASCO Solar 465	28	3
VASCO Solar 485	28	3
VASCO Solar 212 MP	8,2	2
VASCO Solar 409 MP	8,3	2
VASCO Solar 412 MP	8,5	2
VASCO Solar 415 MP	8,5	2
VASCO Solar 418 MP	8,7	2
VASCO Solar 425 MP	8,7	2
VASCO Solar 430 MP	8,7	2
VASCO Solar 438 MP	33	3
VASCO Solar 448 MP	33	3
VASCO Solar 465 MP	34	3
VASCO Solar 485 MP	34	3

SIZE 2

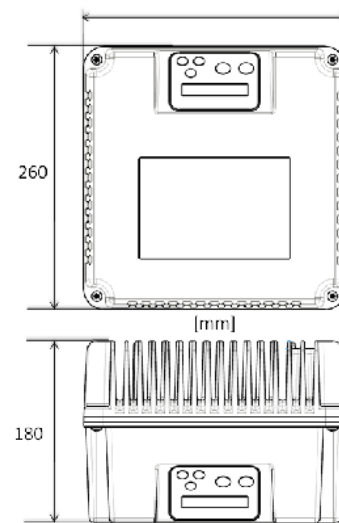

SIZE 3

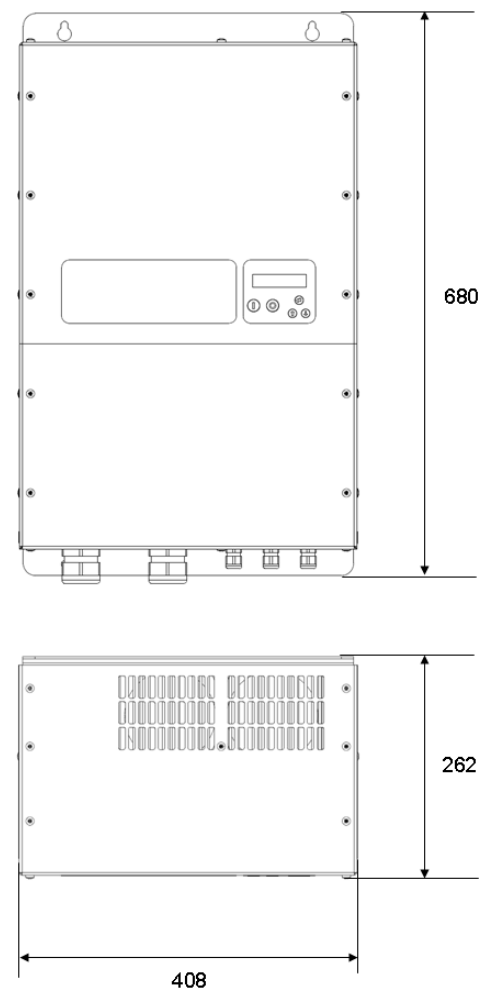

4. Electric wiring

Power board VASCO Solar (Size 2)

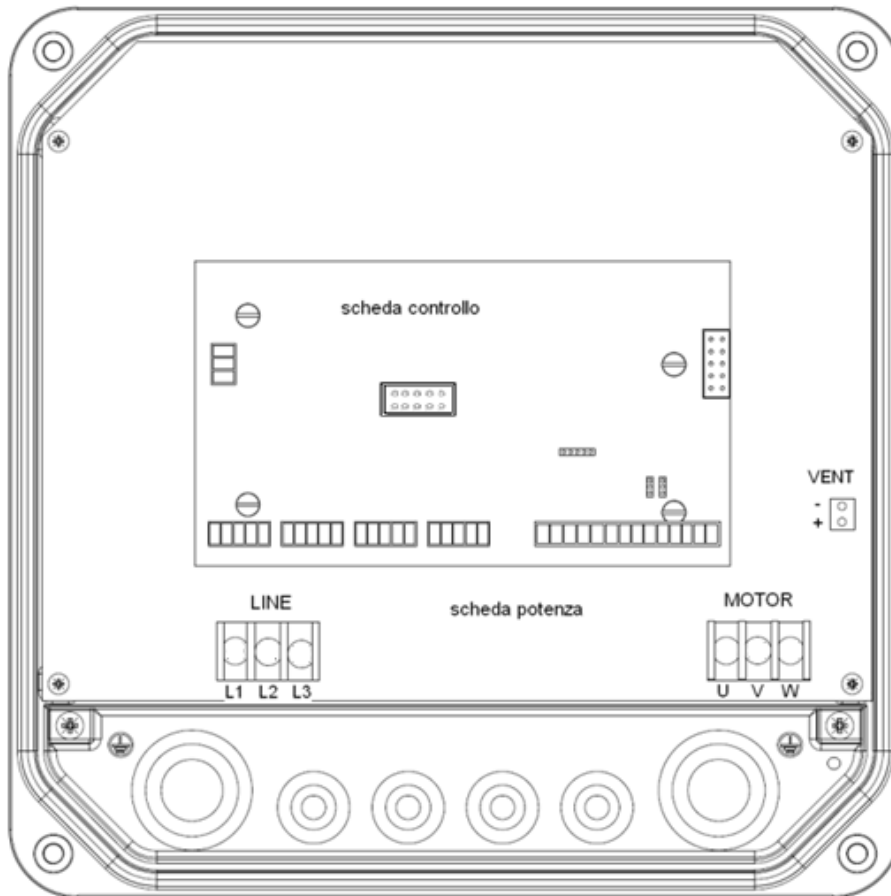

<p>Input: DC: L1, L3, GND It is not necessary to respect polarity. It is recommended to use cable lugs.</p>	<p>Motor output: MOTOR: U, V, W, GND It is recommended to use cable lugs.</p>	<p>12 V dc auxiliary fans (wall mounting kit) VENT: +, - WARNING: respect the polarity.</p>
---	--	---

Cable stripping recommended for line input and output to the motor.

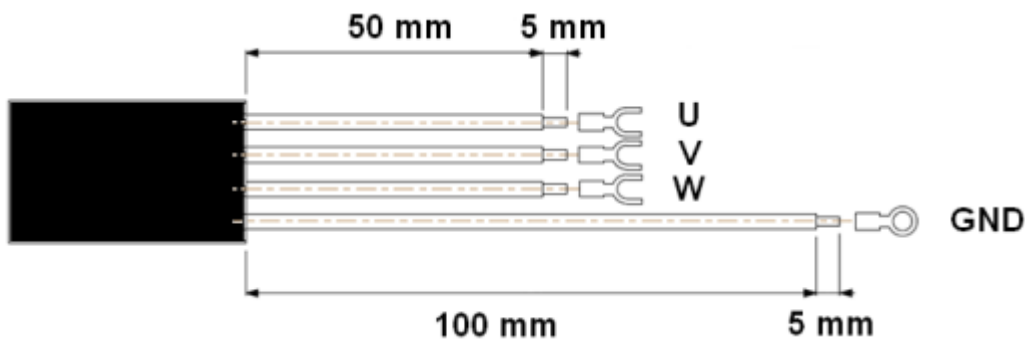

Power board VASCO Solar (Size 3)

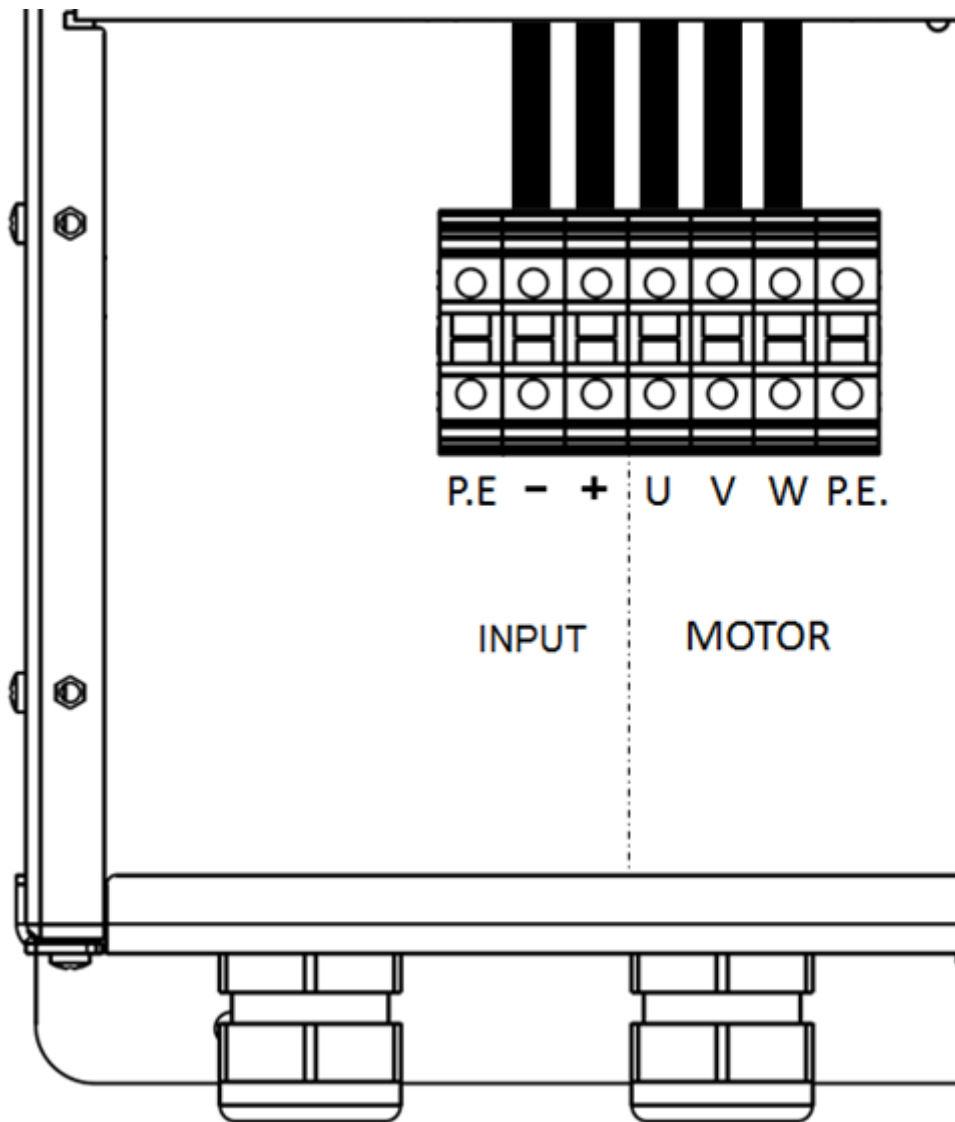

<p>Power supply:</p> <p>INPUT: P.E. , - , +</p> <p>It is necessary to respect the polarity</p> <p>It is recommended to use cable lugs.</p>	<p>Motor output:</p> <p>MOTOR: U, V, W, P.E.</p> <p>It is recommended to use cable lugs.</p>
--	---

Cable stripping recommended for motor cables.

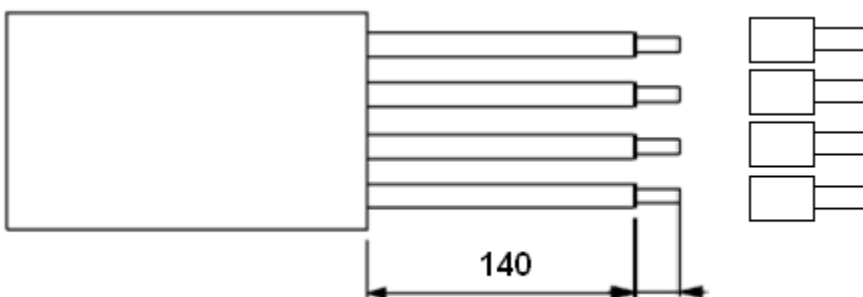

Power board VASCO Solar MP (Size 2)

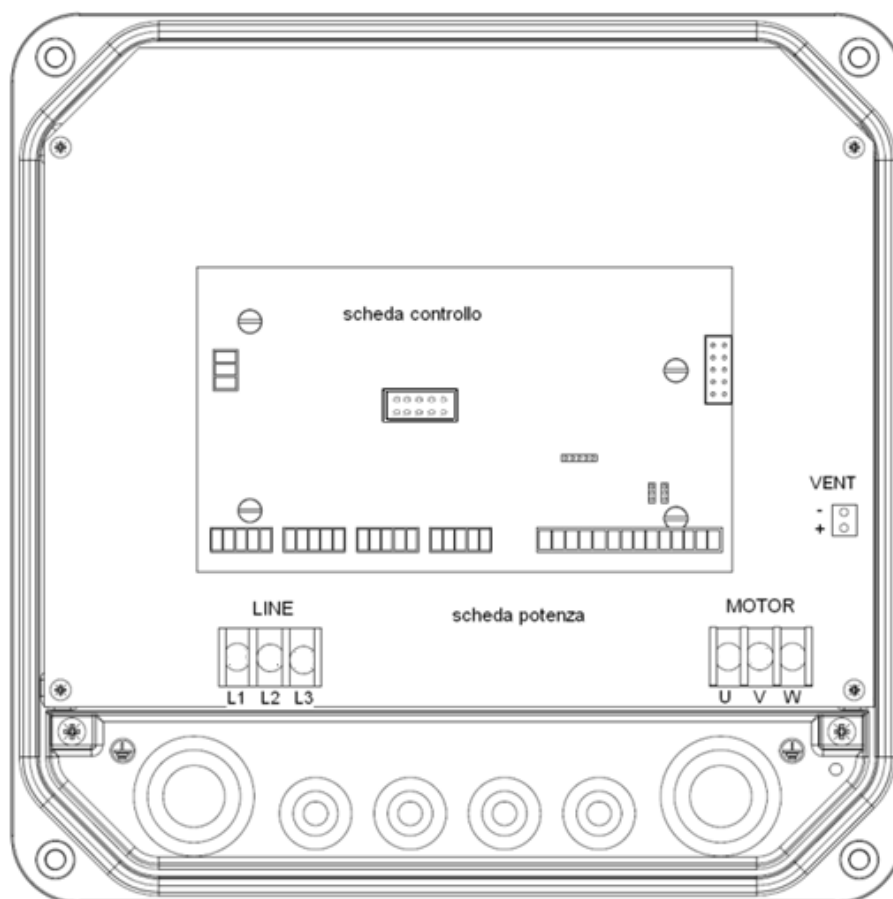

<p>Input:</p> <p>AC: L1, L2, L3, GND</p> <p>DC: L1, L3, GND</p> <p>It is not necessary to respect polarity.</p> <p>WARNING: connect only a power source (DC or AC) at a time.</p> <p>It is recommended to use cable lugs.</p>	<p>Motor output:</p> <p>MOTOR: U, V, W, GND</p> <p>It is recommended to use cable lugs.</p>	<p>12 V dc auxiliary fans (wall mounting kit)</p> <p>VENT: +, -</p> <p>WARNING: respect the polarity.</p>
--	---	---

Cable stripping recommended for line input and output to the motor.

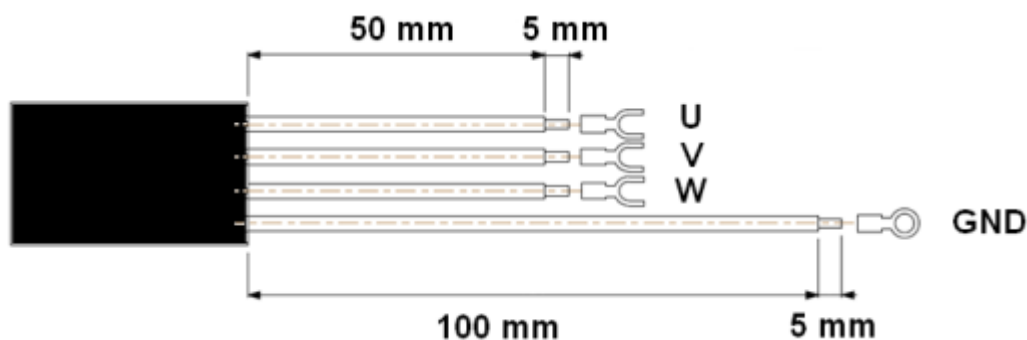

Power board VASCO Solar MP (Size 3)

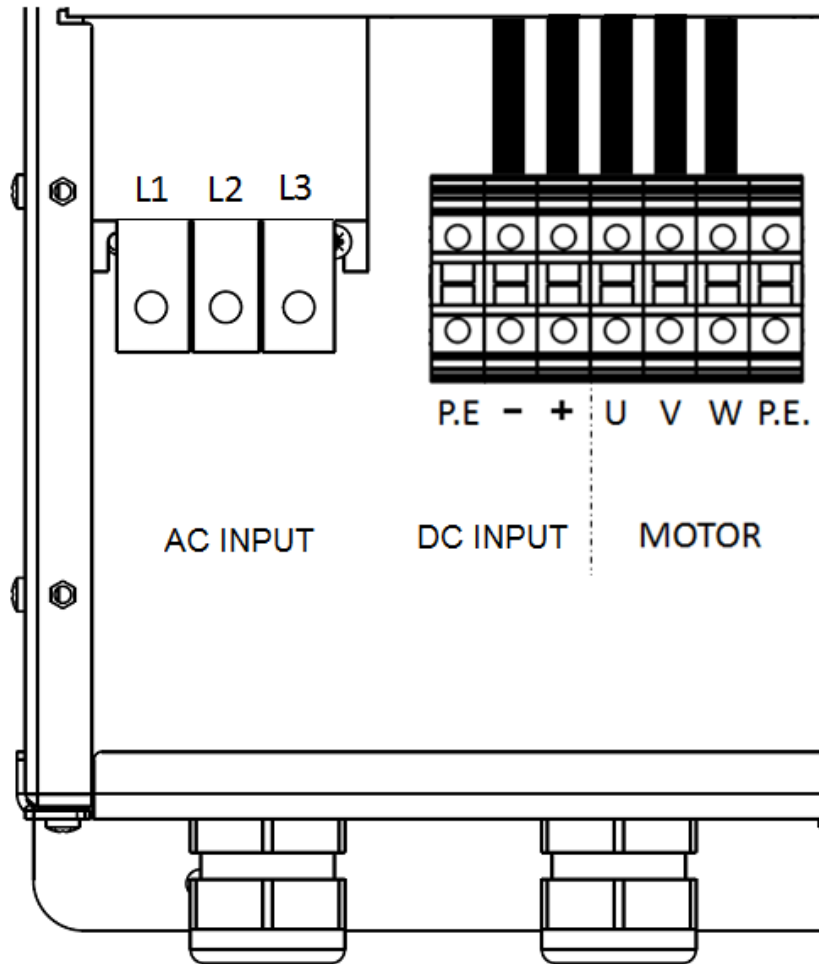

Input:

AC: L1, L2, L3, P.E.

DC: P.E. , - , +

It is necessary to respect the polarity.

WARNING: connect only a power source (DC or AC) at a time.

It is recommended to use cable lugs.

Motor output:

MOTOR: U, V, W, P.E.

It is recommended to use cable lugs.

Cable stripping recommended for motor cables.

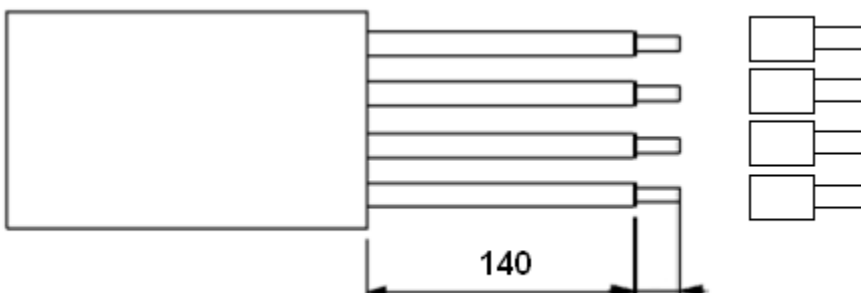

Control board

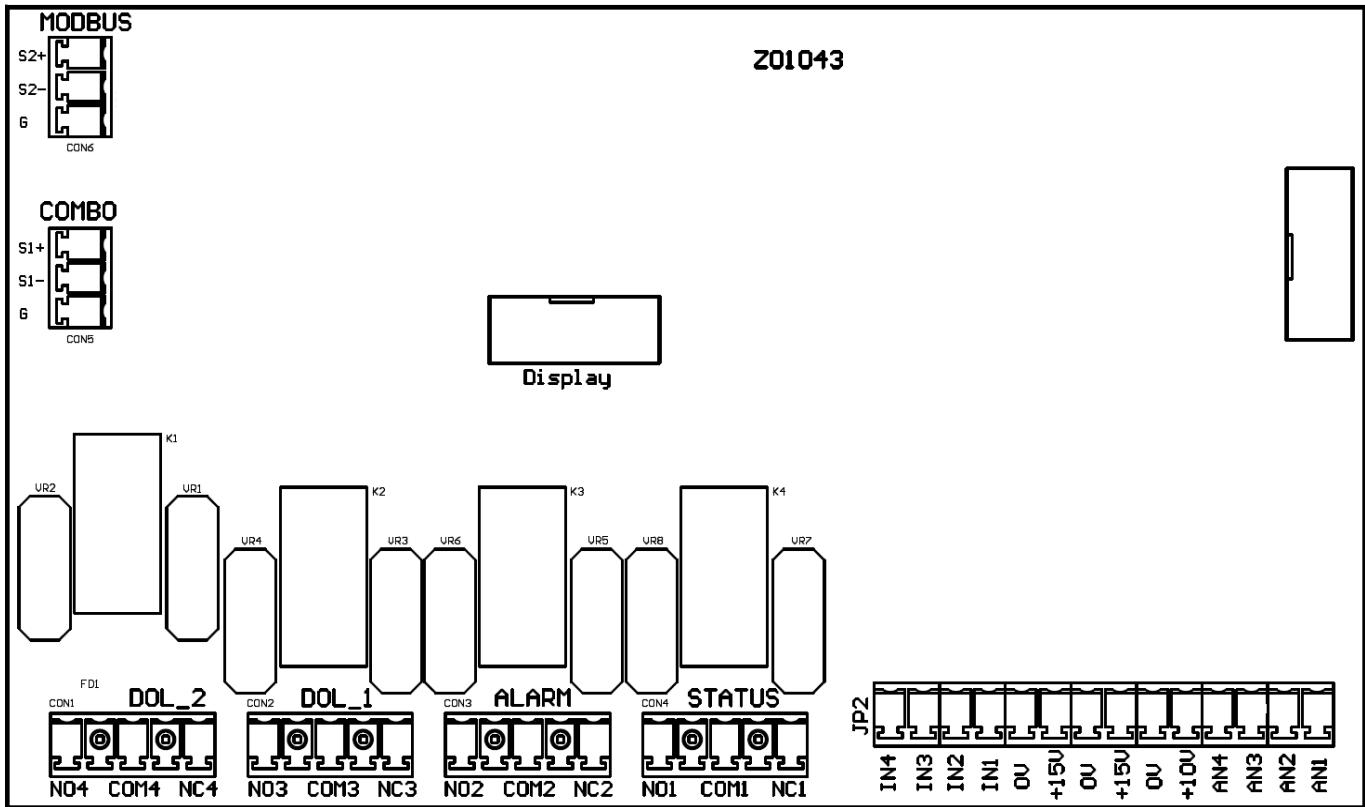

<p>Analog inputs (10 or 15 Vdc):</p> <ol style="list-style-type: none"> 1. AN1: 4-20 mA: sensor 1 2. AN2: 4-20 mA: sensor 2 3. AN3: 4-20 mA / 0 - 10 Vdc (settable by jumper C.C.): external set 4. AN4: 4-20 mA / 0 - 10 Vdc (settable by C.C.): trimmer for frequency regulation / external set 2 	<p>Digital outputs:</p> <ul style="list-style-type: none"> • motor run signal: NO1, COM1: closed contact with motor running. NC1, COM1: closed contact with motor stopped. • alarm signal NO2, COM2: closed contact without alarm. NC2, COM2: closed contact with alarm or no power supply. • DOL1 pump relay: NO3, COM3: closed contact with DOL1 running. NC3, COM3: opened contact with DOL1 running. • DOL2 pump relay: NO4, COM4: closed contact with DOL2 running. NC4, COM4: opened contact with DOL2 running. <p>Relays are no voltage contacts. Max. voltage to the contacts is 250 V with max current of 5 A.</p>	<p>RS485 for COMBO:</p> <ul style="list-style-type: none"> • S1+ • S1- • G <p>It is recommended to respect the polarity linking more VASCOS in series.</p>
<p>Digital inputs:</p> <ul style="list-style-type: none"> • IN1 : motor start & stop • IN2: value set 1 & 2 switching • IN3: sensor 1 & 2 switching • IN4 : motor start & stop + alarms reset • 0V <p>We recommend using only no voltage contacts. Opening or closing the digital contacts (depending on software configuration set (see IN/OUT. parameters) you can start or stop the motor.</p>		<p>RS485 for MODBUS:</p> <ul style="list-style-type: none"> • S2+ • S2- • G <p>It is recommended to respect the polarity.</p>

4.1 Protections

The protections required upstream each VASCO Solar MP depends on the type of installation, and local regulations.

Safety protections on both AC and DC side must be used.

For DC side we recommend to use 1000 VDC circuit breaker and, if possible, 1000 VDC surge protection.

For AC side we recommend to use overload protection with the characteristic curve of type C and type B circuit breaker, sensitive to both AC and DC current.



4.2 Electromagnetic compliance

To ensure electromagnetic compatibility (EMC) of the system, it is necessary to apply the following measures:

- Always connect the device to ground
- Use shielded signal cables by placing the screen at one end.
- Use motor cable as short as possible (<1 m / <3 ft). For longer lengths, it is recommended to use shielded cables connecting the screen at both ends.
- Separate signal, motor, and power supply cables.

Note: To enable the restoration of the display screen when there are electromagnetic interference, VASCO Solar periodically provides some fast "refresh" of the display.

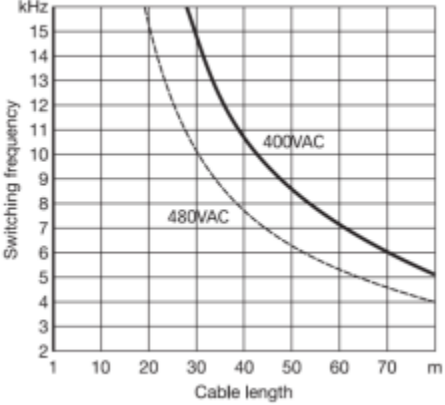
4.3 Installation with long motor cables

<p>With long motor cables it's recommended to decrease the commutation frequency from 10 kHz (default) to 2.5 kHz (motor parameters). This reduces the probability of voltage spikes in the motor windings which may damage the insulation.</p>	 <p>To prevent dangerous overheating of dv / dt and sinusoidal filters it is recommended to set the correct PWM value in relation to the cable length.</p>
<p>For motor cable lengths up to 50 meters it's recommended to place between VASCO Solar and motor a dv / dt reactance, available on request.</p> 	<p>For motor cable lengths greater than 50 meters it's recommended to place between VASCO Solar and motor a sinusoidal filter, available on request.</p> 

5. VASCO Solar installation (Size 2)

- n.° 2 12 V DC fans.
- n.° 1 fans cover.
- n.° 2 fans cover fixing screws
- n.° 2 wall fixing brackets
- n.° 4 M5 screws for VASCO Solar fixing to the brackets
- n.°1 holes reference sheet

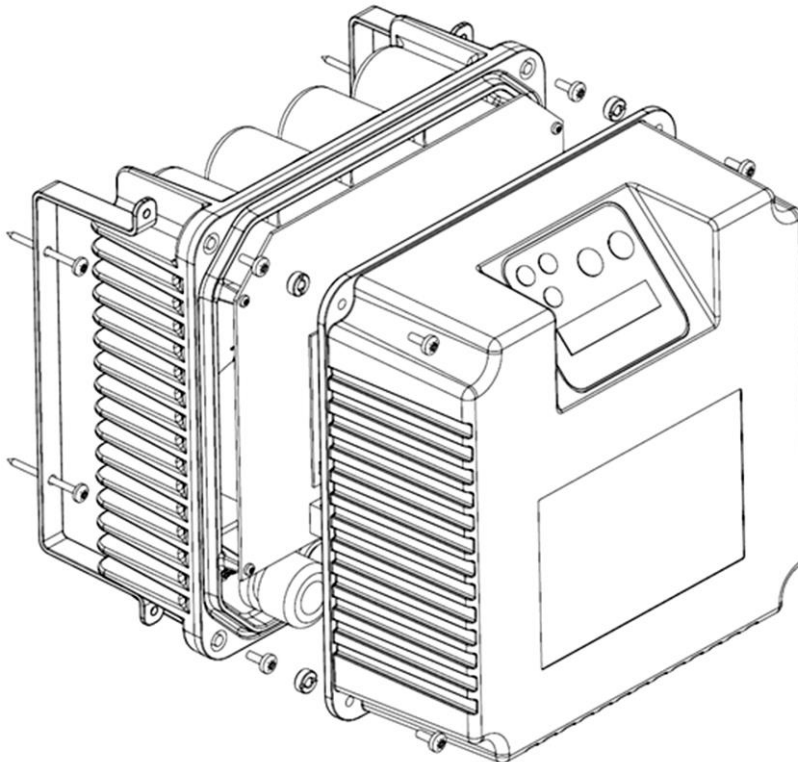
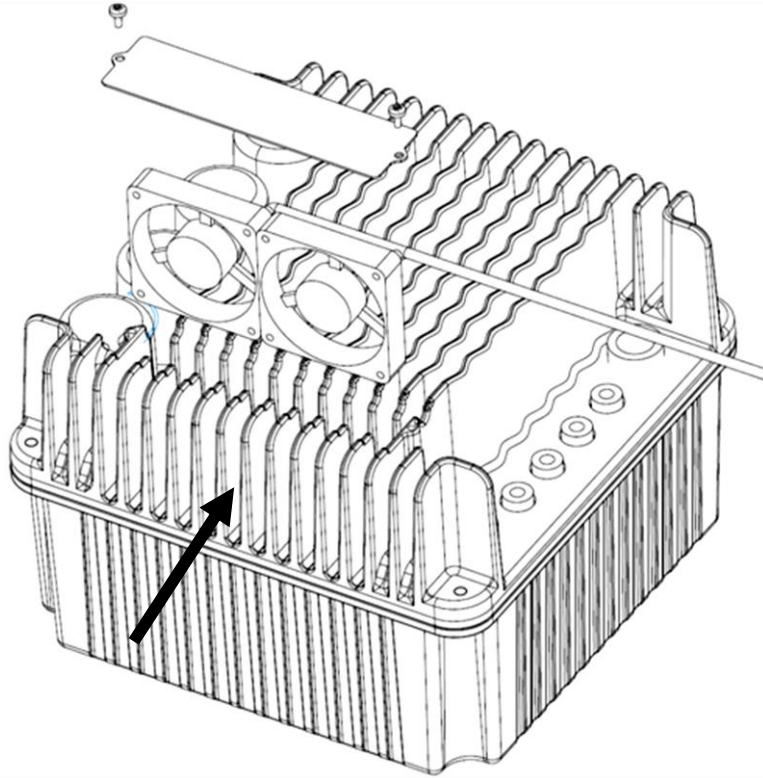

6. PV system sizing

The pumping system must be designed considering daily flow rate required, total head and installation site. In particular, the choice of the pump must be carried out considering the average daily radiation.

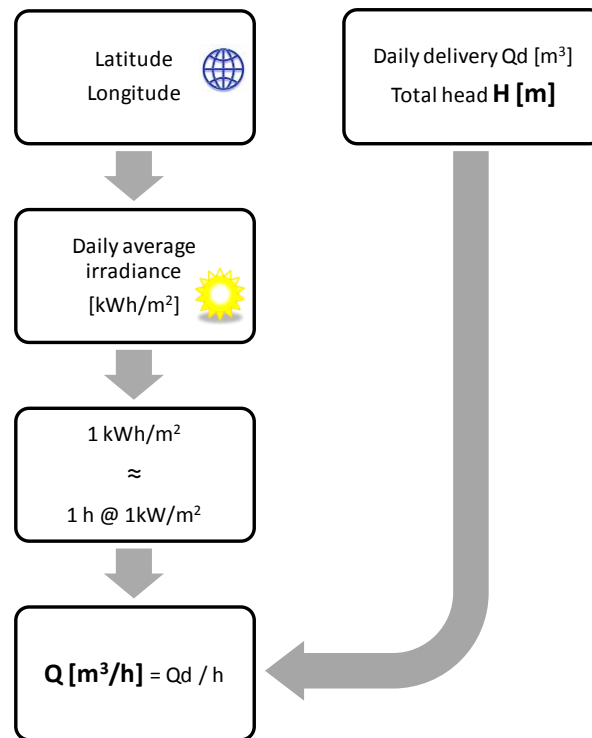

Once determined the required pump, must need to know:

- Rated pump power (P2)
- Electrical motor power (P1). P1 can be derived by dividing P2 with motor efficiency.
- Rated motor current
- Rated motor voltage (3 x 230 VAC or 3 x 400 VAC)

VASCO Solar model to be used is determined by considering voltage and rated motor current.

To ensure maximum performance, the PV system, consisting of 1 or more strings of solar panels connected in series, must provide:

- Electrical motor power (P1)

The photovoltaic power (Wp) must be at least equal to the electric motor power (P1). Typically, taking into account the efficiency loss due to panels temperature, it is recommended to increase Wp of 15% respect to P1.

- Rated motor voltage at maximum power

The rated voltage of each PV string (Vmp) must be at least equal to the rated motor voltage multiplied by the factor 1,4.

- The open-circuit voltage of each string (Voc) must be less than the maximum operating voltage of VASCO Solar.

Example:

Pump nameplate

- Rated motor power: P2 = 3 kW
- Electric motor power: P1 = 4 kW
- Rated motor current: 8.3 A
- Rated motor voltage: 3 x 400 VAC

VASCO Solar selection

Being the rated motor voltage 400 VAC and the rated current 8.3 A, the most suitable model for the application is VASCO Solar 409.

PV system sizing

PV panels used:

- $W_p = 240 \text{ W}$
- $V_{mp} = 30 \text{ VDC}$
- $V_{oc} = 37 \text{ VDC}$
- $I_{mp} = 8 \text{ A}$

Since $P_1 = 4 \text{ kW}$, considering efficiency loss due to temperature, the required electrical power is increased of 15% so $W_p = 4.6 \text{ kW}$.

To develop 4.6 kW are needed 19 panels of 240 W.

$V_{mp} = 19 \times 30 = 570 \text{ VDC}$ is greater than the rated motor voltage multiplied by 1.4 ($400 \times 1.4 = 560 \text{ VDC}$) and $V_{oc} = 19 \times 37 = 703 \text{ VDC}$ is less than the maximum voltage of VASCO Solar 409 (850 VDC).

For this reason a single string of 19 PV panels can be installed.

7. VASCO Solar Installation for constant pressure control

VASCO Solar, apart from MPPT control, offers other several operation modes such as constant pressure with 1 or 2 reference values.

This last operation mode is particularly indicated in those plants where it's preferred to store electrical energy in batteries and use it when it occurs.

To ensure maximum energy saving, and lengthen batteries life, it's useful to select constant pressure mode in which the pump speed, and so the power consumption, is varied while maintaining a constant desired pressure.

VASCO Solar controls the pump speed to maintain constant pressure at a set point independent of the water demand in the system. A basic schematic is shown below:

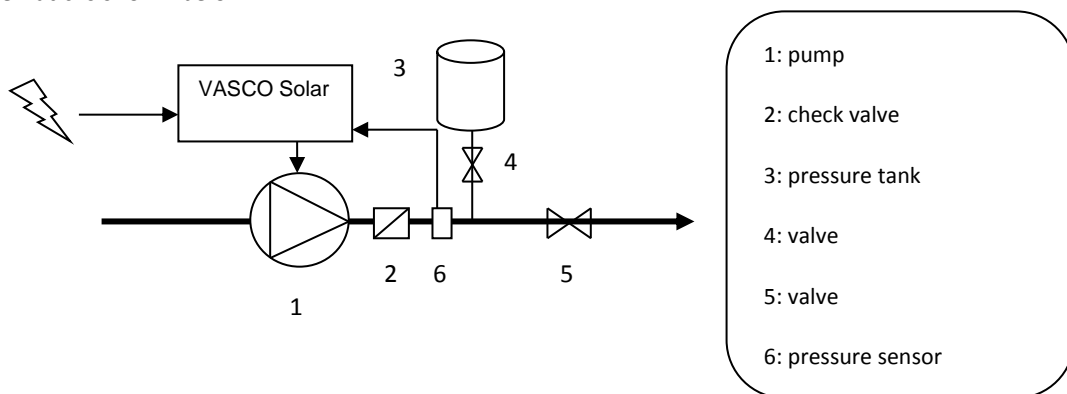

7.1.1 Pressure tank

Installation of a pressure tank in the hydraulic system is recommended to compensate leakage of water in the system (or during minimum water demand) and to avoid continuous start/stop cycling of the pump (check the appendix for more information). Selecting the proper volume and pre-charge pressure of the tank is very important; smaller tank volumes will not compensate adequately for minimum water usage or leakage, while larger volumes make it more difficult for VASCO Solar to control the pressure evenly.

Recommended tank volume is equal to the 10% of the maximum water flow of the system (expressed in volume unit/min)

Example: if the max water flow is 50 liters/min, the pressure tank should have a capacity of 5 liters

if the max water flow is 20 gpm, the pressure tank should have a capacity of 2 gallons

Pre-charge pressure of the pressure tank should be at least 80% than the set-pressure of the system.

Example: if the set-pressure of the system is 4 bar, the pre-charge pressure of the tank should be 3.2 bar

if the set-pressure of the system is 60 psi, the pre-charge pressure of the tank should be 48 psi

7.1.2 Pressure sensor

VASCO Solar requires a pressure sensor with a linear output signal within the range 4 – 20 mA. The pressure transducer can be powered by any range of DC Voltage which includes the value 15 V dc.

VASCO Solar accepts the signal of a second pressure sensor in order to:

- realize constant differential pressure (AN1 – AN2).
- substitute first pressure sensor when it fails
- switch pressure sensor by closing digital input IN2

SENSOR 1	<ul style="list-style-type: none"> • AN1: 4-20 mA (-) signal • +15V: 15 Vdc (+) power supply
SENSOR 2	<ul style="list-style-type: none"> • AN2: 4-20 mA (-) signal • +15V: 15 Vdc (+) power supply

8. VASCO Solar Use and Programming

VASCO Solar software is extremely simple to use, but allows a wide variety of parameters to be set for ideal system calibration. Setting Parameters are organized in 2 levels:

1: Installer level (MENU' CONTROL PARAMETERS, MENU' IN/OUT PARAMETERS, MENU' CONNECTIVITY PARAM.)

A password is required for this level; these parameters are adjustable by trained professionals

Default password: **001**

From the menu a different password can be set up.

2. Advanced level (MENU' MOTOR PARAMETERS)

A second and different password is required; improper setting of these advanced parameters could compromise the integrity and the life of VASCO Solar and pump;

Default password **002**

It is possible to set up a different password.

Installer and Advanced levels can be entered only with the correct password; otherwise, it is impossible to set up and/or modify any parameters (they can be only displayed).

8.1 VASCO Solar display

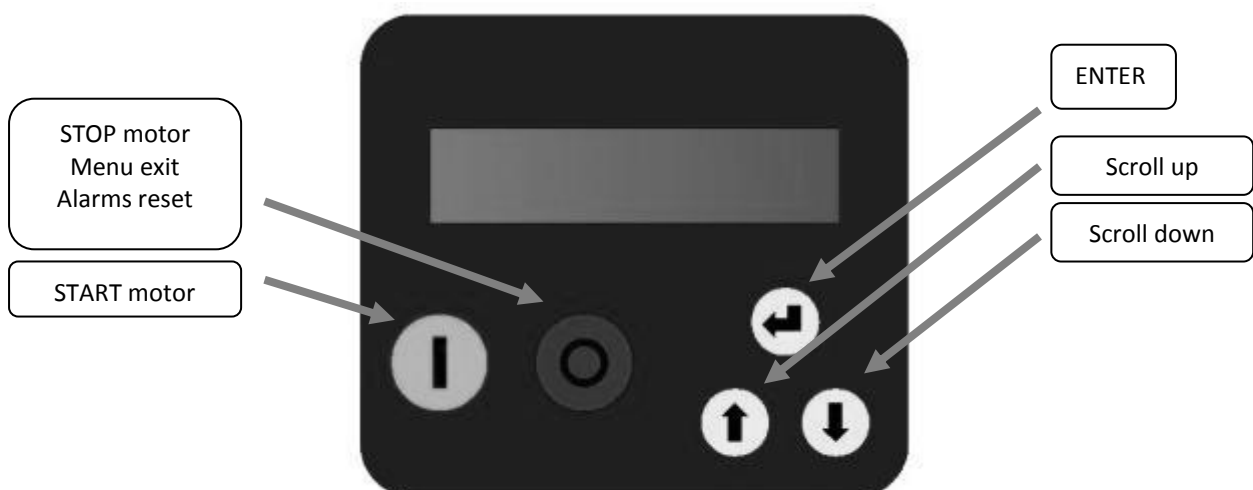

8.2 Initial configuration

When VASCO Solar is switched on for the first time, the initial setting menu is displayed for the initial setting of parameters to configure pump and system characteristics.

If the initial setting procedure is not completed properly, it is impossible to run the pump. Initial setting procedure can be repeated if necessary.

The initial setting procedure can be repeated (by using the 2nd level password) to reconfigure VASCO Solar or if VASCO Solar is installed in a different system.

A brief description of parameters and their allowable ranges are listed below:

Parameter	Default	Description
Language XXXXXX	XXXX	End user communication language
Motor type XXXXXX	three-phase	Type of motor connected: <ul style="list-style-type: none"> asynchronous three-phase synchronous PM (permanent magnets)
Open circuit Volt. PV V = XXX [V]	XXX	Open circuit voltage of PV strings. Please refer to PV panels datasheet.
Rated motor Volt. V = XXX [V]	XXX	Motor rated voltage (as shown in the motor plate) Average voltage drop due to the inverter is between 20 V and 30 Vrms based on load condition.
Rated motor Amp. I = XX.X [A]	XX	Rated current of the motor per it's nameplate indication increased by 10%. The voltage drop caused by the inverter leads to higher input current than nominal. Make sure motor is capable of accepting increased current.
Rated motor freq f = XXX [Hz]	50	Rated frequency of the motor per its nameplate.
MOTOR TUNING press ENT		If the device is "FOC-ready", motor calibration must be carried out before commissioning. Carefully read the pertinent chapter.
Control mode: MPPT		
Motor test START/STOP		Press START/STOP to run a test at rated frequency Warning: make sure to run the system without damaging pump and system
Rotation sense ---> / <---	--->	If, during the test, the motor runs in reverse, it is possible to change the wiring sequence via software without physically changing wires at the terminals.
Autorestart ON/OFF	OFF	If ON is selected, after a lack of voltage, VASCO Solar returns to its normal status; if VASCO Solar was powering the pump before the voltage drop, it resumes powering the pump automatically. <u>Warning</u> , review the advice in chapter 1
INITIAL SETUP COMPLETED		Once the Setting procedure is completed you will get this indication on the display; setting parameters are recorded by VASCO Solar; these parameters can be set up individually in the INSTALLER Parameters menu or ADVANCED Parameters menu.

8.2.1 FOC motor control

Introduction

FOC (Field Oriented Control) motor control implemented in FOC-ready inverters provides the following advantages compared to traditional control:

- Optimal control of the current at each work point.
- Quick and precise speed adjustment.
- Lower energy consumption.
- Reduction of torque oscillations (vibrations) for smoother and more regular operation throughout the frequency range and lower system noise.
- Lower mechanical stress on the motor, pump and hydraulic system.

FOC control of FOC-ready devices can be used with:

- Asynchronous three-phase motors
- Permanent magnet three-phase synchronous motors

The control is sensorless, i.e. not requiring the use of any sensors.

Calibration of the FOC control

To enable the device to perform FOC control, it is necessary to:

1. Perform all system wiring. Connect the load (pump) to the inverter with a cable of appropriate length and possible presence of a dV/dt or sinusoidal filter.
2. Power the system and follow the initial configuration procedure by specifying:
 - a) Motor type: three-phase asynchronous or permanent magnet synchronous.
 - b) Rated voltage of the motor.
 - c) Rated frequency of the motor.
 - d) Rated current of the motor increased by 5%.
3. Perform the Auto tuning process to allow the inverter to learn the electrical information of the load connected to it (motor, cable and any filter). The calibration process can take up to one minute.
4. Wait for the calibration process to complete successfully.



During the calibration process the motor remains stationary but is powered for the entire calibration period. Disconnect the device from the power supply before any intervention on the equipment and on the loads connected to it. Carefully follow the safety instructions in the installation and operating manual of the device.



The calibration process can take up to one minute. Wait until it has completed. The calibration process must be performed during the final electrical configuration of the system, i.e. with the motor, the cable and any filter applied. If there is any variation of the motor, cable or filter applied, it is necessary to repeat the calibration process by accessing the motor parameters menu (default password 002). An incorrect configuration of the motor's rated voltage, frequency or current will lead to erroneous results in the calibration process and therefore to a malfunctioning of the motor. Setting the rated motor current higher than the tag value can seriously damage both the motor and the inverter. During calibration the motor coils are heated by the test current. If the motor is self-ventilated the absence of motor rotation does not allow the heat to be dispersed by force. It is therefore recommended to allow the motor to cool between one calibration and the next.

If the calibration process is not successful, it is necessary to check:

- The connections between the inverter and the load (including any motor filters in between).
- The rated voltage, frequency and current values set.

	<p>The motor cannot be started until the calibration process has been completed. If the calibration process cannot be completed, it is possible to manually enter the parameters or stator resistance (Rs) and stator inductance (Ls) in the motor parameters menu (default password 002). These data can be provided by the motor manufacturer or obtained through measurements. If you do not have these data and the self calibration process is not successful, it is recommended to contact technical assistance.</p>
---	--

Adjustment of the FOC control

The FOC control algorithm checks current (torque) and speed with defined response dynamics.

The FOC dynamic is set by default to a value sufficient to guarantee precise and oscillation-free control in most applications.

In some cases, however, it may be necessary to increase (if there are frequency oscillations) or to lower (in the event of overcurrent or igbt trip alarms) the "FOC dynamic" setting in the motor parameters menu (default password 002) according to the following table :

CONFIGURATION	FOC DYNAMIC
Motor cables shorter than 100 m and no filter between inverter and motor.	200
Motor cables shorter than 100 m and a dV/dt filter between the inverter and the motor.	150
Motor cables longer than 100 m and a dV/dt filter between the inverter and the motor.	100
Presence of a sinusoidal filter between the inverter and the motor.	50

	<p>The incorrect setting of the FOC dynamic can cause:</p> <ul style="list-style-type: none">• Speed oscillations if the FOC dynamic is too slow.• Overcurrent or igbt trip alarms if the FOC dynamic is too fast. <p>It is recommended to intervene promptly by appropriately adjusting the "FOC Dynamic" parameter if the conditions listed above are present. Lack of intervention could lead to damage to the inverter, the motor and the system.</p>
---	---

8.3 Initial view

When first powering the VASCO Solar, the display shows : release of display software (LCD = X.XX) and the release of inverter software (INV = X.XX) as shown below:

LCD = X.XX

INV = X.XX

The following End User messages are displayed by pushing the scroll buttons:

Inv: ON/OFF Mot: ON/OFF p = XX.X [bar]	<i>p is the pressure value read by the pressure transducer. By pressing ENTER the pressure set value is displayed <XXX.X></i>
Inv: ON/OFF Mot: ON/OFF V_in = XXX [Hz]	V_in is the line voltage.
Inv: ON/OFF Mot: ON/OFF I= XX.X [A]	I is the the absorbed motor current.
Inv: ON/OFF Mot: ON/OFF cosphi = XXX	cosphi index means the angle phi between the voltage and current absorbed by the motor
Inv: ON/OFF Mot: ON/OFF P = XXXXX [W]	P is the power in Watts supplied to the pump.
Inv: ON/OFF Mot: ON/OFF STATUS: NORMAL Inverter Life xxxxx h : xx m Motor Life xxxxx h : xx m %f 25 50 75 100 %h XX XX XX XX XXXXXXXXXXXXXXXX XXXXXXXX h : XX m	NORMAL status means no alarms. If an alarm occurs, a message blinks on the display and an audible signal is activated. Pressing ENTER accesses: VASCO Solar lifetime, PUMP lifetime, consumption statistic, alarm list. To return to previous views, press ENTER.

First row gives the VASCO Solar status:

- **Inv: ON XXX.X Hz** VASCO Solar is powered and is powering the motor showing its frequency.
- **Inv: ON Mot: OFF** VASCO Solar is powered but motor is not running
- **Inv: OFF Mot: OFF** VASCO Solar is not powered

If COMBO function is activated, the VASCO Solar address is placed close to indication “Inv”.

8.4 Menu view

Pressing ENTER when you are in [MENU' / ENT to access] in initial display, will display the following MENUS:

	MENU' Control. param.		Installer password required to enter level 1 (default 001)
	MENU' Motor param.		Advanced password required to enter level 2 (default 002)
	MENU' IN/OUT. param.		Installer password required to enter level 1 (default 001)
	MENU' Connect. param.		Installer password required to enter level 1 (default 001)
	MENU' Change init.set.		Advanced password required to enter level 2 (default 002)

To exit the Menu level and return to initial display, press STOP button.

8.5 Control parameters

Parameter	Default	Description	Constant value	Fix speed	Const.value 2 set	Fix speed 2 val.	External speed
<div style="border: 1px solid black; padding: 5px;"> <p>Control mode</p> <ul style="list-style-type: none"> • MPPT • Constant value • Fix speed • Const.value 2set • Fix speed 2 val. • External speed </div>	MPPT	<p>Mode of control:</p> <ul style="list-style-type: none"> • MPPT: pump speed is adjusted in order to obtain maximum power available from PV panels. • Constant value: VASCO Solar changes the pump speed to keep the set value constant regardless water demand. • Fix speed: VASCO Solar feeds the pump at set frequency, so the pump speed is kept constant. • Const. value 2 set: the two values are selected by opening or closing the digital input IN2. • Fix speed 2 val: the two values are selected by opening or closing the digital input IN2. • External speed: control motor frequency by using analogical input AN4. 					
<div style="border: 1px solid black; padding: 5px;"> <p>Max alarm value</p> <p>XXX.X [bar]</p> </div>	10	<p>Maximum value allowed in the system. If the readen value goes over this value, an alarm occurs and the pump is stopped. Pump is automatically restarted if the readen value goes below the maximum value for a period of at least 5 seconds.</p>	✓	✓	✓	✓	✓

Parameter	Default	Description	Constant value	Fix speed	Const. value 2 set	Fix speed 2 val.	External speed
Min alarm value XXX.X [bar]	0	Minimum value allowed in the system. If the readen value goes lower than this value, an alarm occurs and the pump is stopped. Pump is automatically restarted if the readen value goes higher than the minimum value for a period of at least 5 seconds.	✓	✓	✓	✓	✓
Ext.set enabling ON/OFF	OFF	Enabling of set value changing by analog input AN3.	✓		✓		
Set value XXX.X [bar]	3	Set value to be kept constant.	✓				
Compensation XXX.X [bar]	0	Value compensation at the maximum frequency for each pump. Acting on the green button you can reverse the sign.	✓				
Set value 2 XXX.X [bar]	3	Set value to be kept constant.			✓		
Compensation 2 XXX.X [bar]	0	Value compensation at the maximum frequency for each pump. Acting on the green button you can reverse the sign.			✓		
Set value update XX [s]	5	Time to update set value for compensation.	✓		✓		

Parameter	Default	Description	Constant value	Fix speed	Const.value 2 set	Fix speed 2 val.	External speed
-----------	---------	-------------	----------------	-----------	-------------------	------------------	----------------

To ensure proper operation of pressure control is recommended to place the sensor near the pump.
 To compensate the pressure loss in the pipes (proportional to flow) it is possible to vary the pressure set in a linear relation with respect to frequency.

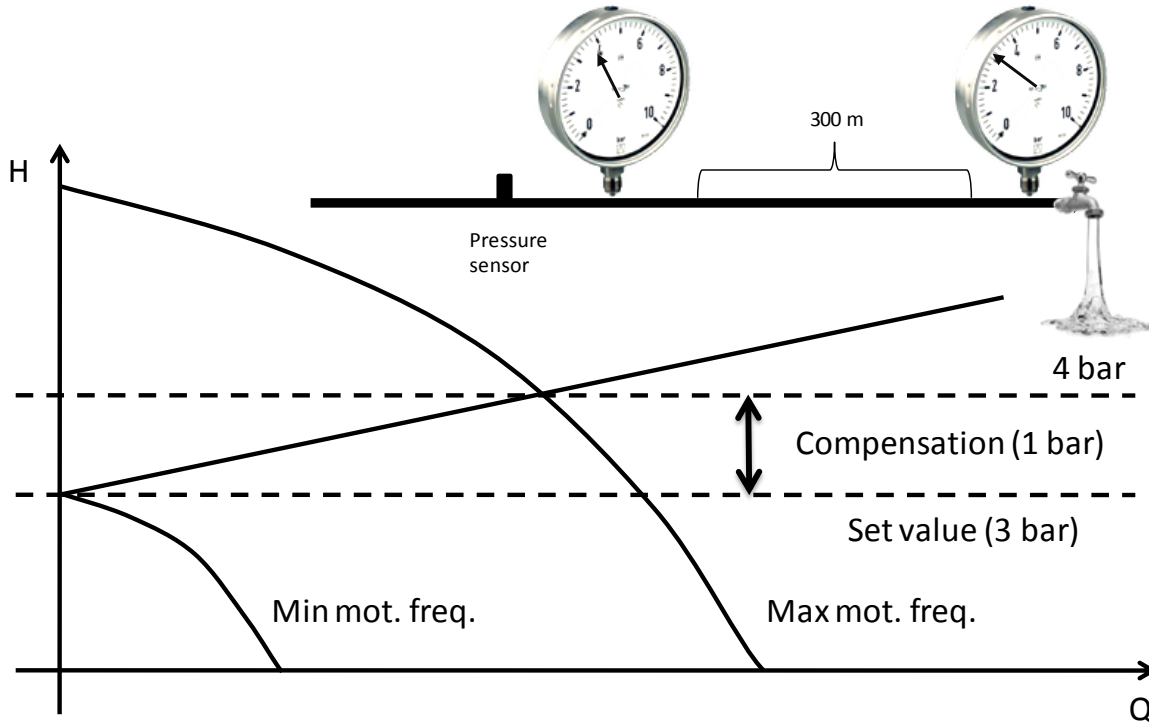

It can perform the following test to verify the correct value of compensation:

1. install a pressure gauge away from the pressure sensor
2. open completely the valve
3. check the pressure gauge

--> Set the value of *compensation*. equal to the difference of the values from the two gauges.

When using a group of pumps, the pressure compensation to be applied to each pump is equal to the total pressure compensation (when all the pumps are running at full speed) divided by the number of pumps in the group.

Operating freq. XXX [Hz]	50	Frequency value to feed the pump.		✓			
Operating freq. 2 XXX [Hz]	50	Frequency value to feed the pump.				✓	
Freq.min.control XXX [Hz]	50	Minimum frequency below which the pump tries to stop.	✓		✓		✓
Stop delay XX [s]	5	Delay for which the pump tries to stop below freq.min.control.	✓		✓		✓
Control ramp XXX.X [s]	20	Ramp time from freq.min.control to min.motor freq. If, during this time, the read value goes below the (set value - delta control), VASCO Solar powers the	✓		✓		✓

Parameter	Default	Description	Constant value	Fix speed	Const. value 2 set	Fix speed 2 val.	External speed
		motor again; otherwise, VASCO Solar will stop the pump.					
Delta control XXX.X [bar]	0.1	Value drop below the set value required to restart the pump during control ramp.	✓		✓		
<p>The graph illustrates the pump's response to a pressure drop. The vertical axis represents frequency in Hz, with markers for 'Min mot. freq' and 'Freq.min.control'. The horizontal axis represents time in seconds. A blue line represents pressure, which starts at a 'Set value', drops slightly, and then recovers to the set value. A red line represents frequency, which starts at 'Min mot. freq', drops to 'Freq.min.control' during a 'Stop delay' period, and then ramps up during a 'Control ramp' period. Two faucet icons are shown: one during the stop delay and one during the control ramp.</p>							
Delta start XXX.X [bar]	0.5	Value drop below the set value required to start the pump from stop condition.	✓		✓		
Delta stop XXX.X [bar]	0.5	Value increase respect to set value which must be passed so that there is a forced shutdown of the pump.	✓		✓		
Ki		Kp and Ki parameters allow the dynamic control of system by VASCO Solar; set values (Ki=50, Kp=005) are usually enough to get a valid dynamic control.	✓		✓		
Kp							
Pump DOL 1 ON/OFF	OFF	Function to activate (ON) the first auxiliary pump DOL 1 (Direct On Line pump).	✓		✓		
Pump DOL 2 ON/OFF	OFF	Function to activate (ON) the second auxiliary pump DOL 2 (Direct On Line pump).	✓		✓		
COMBO ON/OFF	OFF	Enabling or disabling COMBO operation as described in COMBO chapter.	✓		✓		

Parameter	Default	Description	Constant value	Fix speed	Const.value 2 set	Fix speed 2 val.	External speed
Address XX	00	VASCO Solar address: <ul style="list-style-type: none"> • 00 master • 01 to 07 slaves 	✓		✓		
Alternance ON/OFF	OFF	Function to allow alternating between the VASCO Solars connected in COMBO (or pumps connected in DOL) in order to allow equal use of each pump in the group; master will reorganize the starting priority of the pumps by checking the life of each of them.	✓		✓		
Alternance period XX [h]	0	Maximum difference in terms of hours between VASCO Solars in the group. 0 stays for 5 minutes.	✓		✓		
COMBO synchrony ON/OFF	OFF	With this parameter it is possible to activate the synchronous operation (same speed) of the pumps in COMBO. It is however necessary to appropriately lower the parameter "f. min. control".	✓		✓		
Start delay AUX t = XX [s]	0	Delay time with which the slaves start after the variable speed pump has reached the maximum frequency and the pressure value has fallen below set value – delta control	✓		✓		
PI control Direct/Reverse	Direct	Direct: increasing motor speed also misured value increases Reverse: increasing motor speed, misured value decreases.	✓		✓		
Periodic autorun t = XX [h]	0	Pump periodic autorun after XX hours of inactivity. Value 0 makes function disabled. <u>Warning</u> , review the advice in chapter 1.	✓	✓	✓	✓	✓
Dry run cosphi X.XX	0.65	Cosphi value below which the unit stops the motor and give "no water" alarm.	✓	✓	✓	✓	✓
Restarts delay XX [min]	10	Restart delay after a dry running alarm. At each tentative (max 5) restart delay will be doubled.	✓	✓	✓	✓	✓

8.6 Motor parameters

Parameters	Default	Description
Open circuit Volt. PV V = XXX [V]	XXX	Open circuit voltage of PV strings. Please refer to PV panels datasheet.

Rated motor Volt. XXX [V]	XXX	Motor rated voltage (as shown on motor nameplate).
Voltage boost XX.X [%]	0%	Voltage increase during the motor start up. Warning: An excessive value can seriously damage the motor. Contact the motor manufacturer for further information.
Rated motor Amp. XX.X [A]	XX	Rated motor current as per its nameplate indication increased by 5%.
Rated motor freq XXX [Hz]	50	Rated motor frequency as per its nameplate.
Max motor freq. XXX [Hz]	50	Maximum motor frequency. Note: by reducing the maximum motor frequency, maximum current will be reduced as well.
Min motor freq. XXX [Hz]	20	Minimum motor frequency.
Ramp up time XXX.X [sec]	4	Ramp-up time to reach the speed required to achieve the set pressure (or frequency value). Longer times delay the system reaching the preset value but better protect system components. Excessively long ramp-up times can create difficulties in VASCO Solar setup, and can also cause false overload alarms.
Ramp down time XXX.X [sec]	4	Ramp-down time to reach zero speed. Longer times keep the system pressurized, while protecting the system components. Excessively long ramp-down times can create difficulties in VASCO Solar setup. Excessively short ramp-down times can cause false overload alarms.
Ramp f min mot. XXX.X [sec]	1.5	Time to reach the minimum motor frequency and vice versa.
PWM XX.X [kHz]	8	Carrier frequency (switching frequency). It is possible to choose PWM in the range of 2.5 ,4, 6, 8, 10 kHz . Higher values give a more sinusoidal wave with fewer losses for the motor but higher losses for the inverter (increased inverter heating). If long cables

		are used (>20 m / >76 ft) (submersible pump) it is recommended to install an inductive filter between VASCO Solar and the motor (available upon request) and to set the value of PWM to 2.5 kHz. This reduces the risk of voltage spikes, which can damage motor and cable insulation.
<div style="border: 1px solid black; padding: 5px; width: fit-content;"> V/f lin. --> quad. XXX [%] </div>	85 %	V / f characteristic with which VASCO Solar feeds the engine. The linear characteristic corresponds to constant torque with variable speed. The quadratic characteristic is normally used with centrifugal pumps. The selection of torque characteristic should be done ensuring a smooth operation, a reduction of energy consumption and a lower level of heat and acoustic noise.

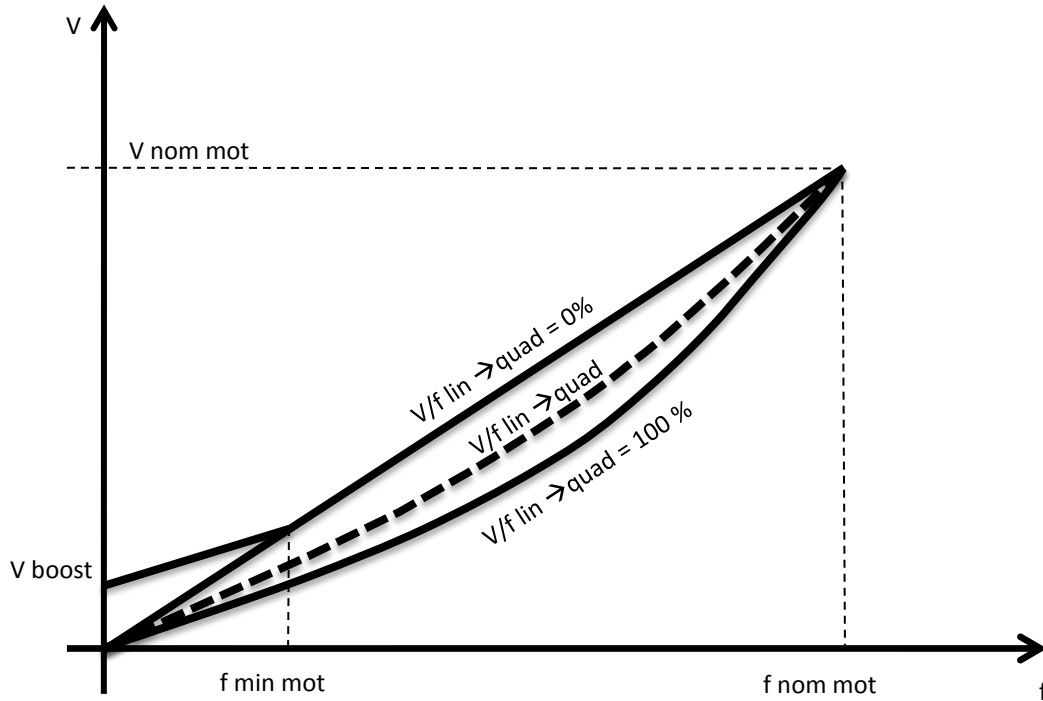

Rotation sense ---> / <---	--->	If, during the test, the motor runs in reverse, it is possible to change the wiring sequence via software without physically changing wires at the terminals.
MOTOR TUNING press ENT		If the device is "FOC-ready", motor calibration must be carried out before commissioning. Carefully read the pertinent chapter.
Mot. resistance Rs=XXX.XX [Ohm]		Manual setting of the stator resistance.
Mot. inductance Ls=XXX.XX [mH]		Manual setting of the stator inductance.
FOC dynamic XXX		Setting of the control dynamic of the FOC algorithm.
Autorestart ON/OFF	OFF	If ON is selected, after a lack of voltage, VASCO Solar returns to its normal status; if VASCO Solar was powering the pump before the voltage drop, it resumes powering the pump automatically. <u>Warning</u> , review the advice in chapter 1.

8.7 IN/OUT parameters

Parameter	Default	Description
Unit XXXXX	bar	Unit [bar,%,ft,in,cm,m,K,F,C,gpm,l/min,m3/h,atm,psi]
F. scale sensor XXX.X	16	Sensor full scale.
Min.value sensor XXX.X	0	Sensor minimum value.
Offset input 1 [%]	20%	Zero correction for analog input 1 (4-20 mA) (20 mA x 20% = 4 mA).
Offset input 2 [%]	20%	Zero correction for analog input 2 (4-20 mA) (20 mA x 20% = 4 mA).
Offset input 3 [%]	0%	Zero correction for analog input 3 (0-10V) (10V x 00% = 0 V).
Offset input 4 [%]	0%	Zero correction for analog input 4 (0-10V) (10V x 00% = 0 V).
AN1,AN2 function XXXXXX	Independent	Function logic for analog input AN1,AN2 (independent, lower value, higher value, difference 1-2).
Digital input 1 N.O. / N.C.	N.O.	By selecting N.O. (normally open) VASCO Solar runs the motor if the digital input 1 is open; motor will be stopped if the digital input 1 is closed. By selecting N.C. (normally closed) VASCO Solar runs the motor if the digital input 1 is closed; motor will be stopped if the digital input 1 is opened.
Digital input 2 N.O. / N.C.	N.O.	By selecting N.O. (normally open) VASCO Solar runs the motor if the digital input 2 is open; motor will be stopped if the digital input 2 is closed. By selecting N.C. (normally closed) VASCO Solar runs the motor if the digital input 2 is closed; motor will be stopped if the digital input 2 is opened.
Digital input 3 N.O. / N.C.	N.O.	By selecting N.O. (normally open) VASCO Solar runs the motor if the digital input 3 is open; motor will be stopped if the digital input 3 is closed.

Parameter	Default	Description
		By selecting N.C. (normally closed) VASCO Solar runs the motor if the digital input 3 is closed; motor will be stopped if the digital input 3 is opened.
<div style="border: 1px solid black; padding: 5px; width: fit-content;"> Digital input 4 N.O. / N.C. </div>	N.O.	By selecting N.O. (normally open) VASCO Solar runs the motor if the digital input 4 is open; motor will be stopped if the digital input 4 is closed. By selecting N.C. (normally closed) VASCO Solar runs the motor if the digital input 4 is closed; motor will be stopped if the digital input 4 is opened.
<div style="border: 1px solid black; padding: 5px; width: fit-content;"> Dig.In.2/3 delay [s] </div>	3	Digital input IN2 & IN3 delay. Digital input IN1 has 1 second fix delay.

8.8 Connectivity parameters

Parameters	Default	Description
<div style="border: 1px solid black; padding: 5px; width: fit-content;"> MODBUS address XXX </div>	1	MODBUS address from 1 to 247
<div style="border: 1px solid black; padding: 5px; width: fit-content;"> MODBUS baudrate XXXXX [bps] </div>	9600	MODBUS baudrate from 1200 bps to 57600 bps
<div style="border: 1px solid black; padding: 5px; width: fit-content;"> MODBUS data format XXXXX </div>	RTU N81	MODBUS data format: RTU N81, RTU N82, RTU E81, ETU O81

9. Protections and alarms

Anytime a protection occurs a blinking message is displayed together with an audible alarm; on STATUS in the initial view, the protection is displayed; by pressing the STOP button. Only from this position (STATUS) in the initial view is it possible to try to reset the alarm; if VASCO Solar does not reset the alarm it is displayed again together an audible sound.

ALARM MESSAGE	ALARM DESCRIPTION	POSSIBLE SOLUTIONS
OVERCURRENT MOT.	<p>Motor overload: input current of the motor is higher than the rated motor current setting parameter.</p> <p>Motor voltage drop caused by the inverter causes the motor input current to be higher than rated. Contact motor manufacturer to check if motor is capable of accepting this current.</p>	<ul style="list-style-type: none"> • Make sure that the motor current setting parameter is higher than rated. • Check other possible causes of over current
UNDER VOLTAGE	Supply voltage too low	Check possible causes of undervoltage
OVER VOLTAGE	Supply voltage too high	Check possible causes of overvoltage
OVER TEMP. INV.	Inverter over temperature	<ul style="list-style-type: none"> • Make sure than ambient temperature is less than 40 °C (104 °F). • Check if auxiliary cooling fan is working properly and if mounting space is adequate for proper cooling. • Reduce the PWM value (<i>Motor Parameter Menu</i>)
NO LOAD	No load	<ul style="list-style-type: none"> • Check if load is properly connected to the VASCO Solar terminals
NO WATER (DRY RUN COSPHI)	Motor cosphi is lower than the set value of dry running cosphi	<ul style="list-style-type: none"> • Check if the pump is primed • Check the set value of dry running cosphi. Dry running cosphi is approximately 60% of the rated cosphi (at rated frequency) listed on the motor plate. <p>If pump's cosphi is lower than the set dry-running cosphi for at least 2 seconds, VASCO Solar stops the pump. VASCO Solar tries to run the pump every 10, 20, 40, 80, 160 minutes and then the pump is stopped.</p> <p>WARNING: if dry running protection occurs, VASCO Solar will try to start the pump automatically. Be sure to cut power supply to VASCO Solar before performing any maintenance.</p>
SENSOR FAULT	Sensor error	<ul style="list-style-type: none"> • Check the transducer • Check the wiring of transducer
MAX. VALUE ALARM	Measured value has reached the maximum value accepted by the system.	<ul style="list-style-type: none"> • Check possible causes of reaching max value • Check the max alarm value setting

MIN. VALUE ALARM	Measured value has reached the lowest value accepted by the system.	<ul style="list-style-type: none"> • Check possible causes reaching min value (i.e. broken pipe, open pressure relief valve, etc.) • Check the min alarm value setting.
IGBT TRIP ALARM	The current drawn by the load exceeds the capacity of VASCO Solar. VASCO Solar is still able to continue to power the load for 10 minutes with an output current of 101% of nominal and for 1 minute with an output current of 110% of nominal	<ul style="list-style-type: none"> • Increase the ramp-up time • Make sure that the load current is at least 10% below the VASCO Solar nominal current • Check the voltage drop along the supply cable to the motor
NO COMMUNICATION	Communication between Master and slave(s) has been interrupted	<ul style="list-style-type: none"> • Check the wiring connections • Make sure the Master is not in the Menu level; if so, exit from the level. • In the STATUS of the slave (where the alarm is displayed) try to reset the alarm by pushing STOP button.
ADDRESS ERROR	Same address as other VASCO Solars in the group	<ul style="list-style-type: none"> • The address of each VASCO Solar needs to be different
KEYBOARD FAULT	A Button on the keyboard has been pressed for more than 150 seconds	<ul style="list-style-type: none"> • Make sure buttons are not depressed • Call service assistance
ACTIVE DIG.IN.X	Digital input X opened /closed	<ul style="list-style-type: none"> • Check the input digital configuration (IN/OUT Parameters menu)
ALARM SLAVE XX	slave XX error detected by master	<ul style="list-style-type: none"> • check the status of the slave
	<p>If pumps cosphi is lower than the dry-running cosphi for at least 2 seconds, VASCO Solar will stop the pump. VASCO Solar will try to run the pump every 10, 20, 40, 80, 160 minutes and then the pump is stopped.</p> <p>ATTENTION: if dry-running protection occurs, VASCO Solar will try to start the pump automatically. Be sure to cut power supply before attempting maintenance</p> <p>VASCO Solar will stop the pump if the input motor current is higher than the set motor current for an extended time. By pressing the START button it is possible to run the pump again.</p> <p>VASCO Solar will stop the pump if the input voltage is higher than the set voltage for an extended time. By pressing the START button it is possible to run the pump again. VASCO Solar will stop the pump if the input voltage is lower than the set voltage for an extended time. By pressing the START button it is possible to run the pump again.</p>	

DECLARATION OF CONFORMITY

In according with:

Machine Directive 2006/42/EC

EMC Directive 2014/30/EU

Low Voltage Directive 2014/35/EU

R&TTE Directive 2014/53/EU

VASCO Solar is an electronic device to be connected to other electrical equipment with which it is to form individual units. It must, therefore, that the putting into service of this unit (with all its subsidiary equipments) to be performed by qualified personnel.

The product conforms to the following regulations:

EN61800-3

EN 61800-6-1

EN 61000-6-3

EN 61000-4-2

EN 61000-4-3

EN 61000-4-4

EN 61000-4-5

EN 61000-4-6

EN 50178

EN 60204-1

Ing. Marco Nassuato
Operation Manager



